

614.252.0955 or 800.845.7644

Visit our website at oberfields.com

What outdoor living should be®

PAVERS • RETAINING WALLS • PATIO STONES • ACCESSORIES



CORPORATE OFFICE

SALES

528 London Road
P.O. Box 362
Delaware, OH 43015
614.252.0955
740.369.7644
800.845.7644
Fax 740.363.7644

SALES & MANUFACTURING

1165 Alum Creek Drive
Columbus, OH 43209
614.252.0955
Fax 614.252.5858

SALES

450 W. Fair Avenue
Lancaster, OH 43130
740.653.3074
Fax 740.653.7285

SALES & MANUFACTURING

980 Shawnee Road
Lima, OH 45805
419.225.6761
Fax 419.225.6121

Oberfields is Ohio's premier manufacturer and marketer of high-quality concrete masonry, landscape, sitescape and building material products. We invite you to visit one of our four showrooms or many distributors throughout the region. Simply call us for a convenient location near you.

Oberfields

©2011 Oberfields



614.252.0955 or 800.845.7644

Visit our website at oberfields.com

What outdoor living should be®

PAVERS • RETAINING WALLS • PATIO STONES • ACCESSORIES



CORPORATE OFFICE

SALES

528 London Road
P.O. Box 362
Delaware, OH 43015
614.252.0955
740.369.7644
800.845.7644
Fax 740.363.7644

SALES & MANUFACTURING

1165 Alum Creek Drive
Columbus, OH 43209
614.252.0955
Fax 614.252.5858

SALES

450 W. Fair Avenue
Lancaster, OH 43130
740.653.3074
Fax 740.653.7285

SALES & MANUFACTURING

980 Shawnee Road
Lima, OH 45805
419.225.6761
Fax 419.225.6121

Oberfields is Ohio's premier manufacturer and marketer of high-quality concrete masonry, landscape, sitescape and building material products. We invite you to visit one of our four showrooms or many distributors throughout the region. Simply call us for a convenient location near you.

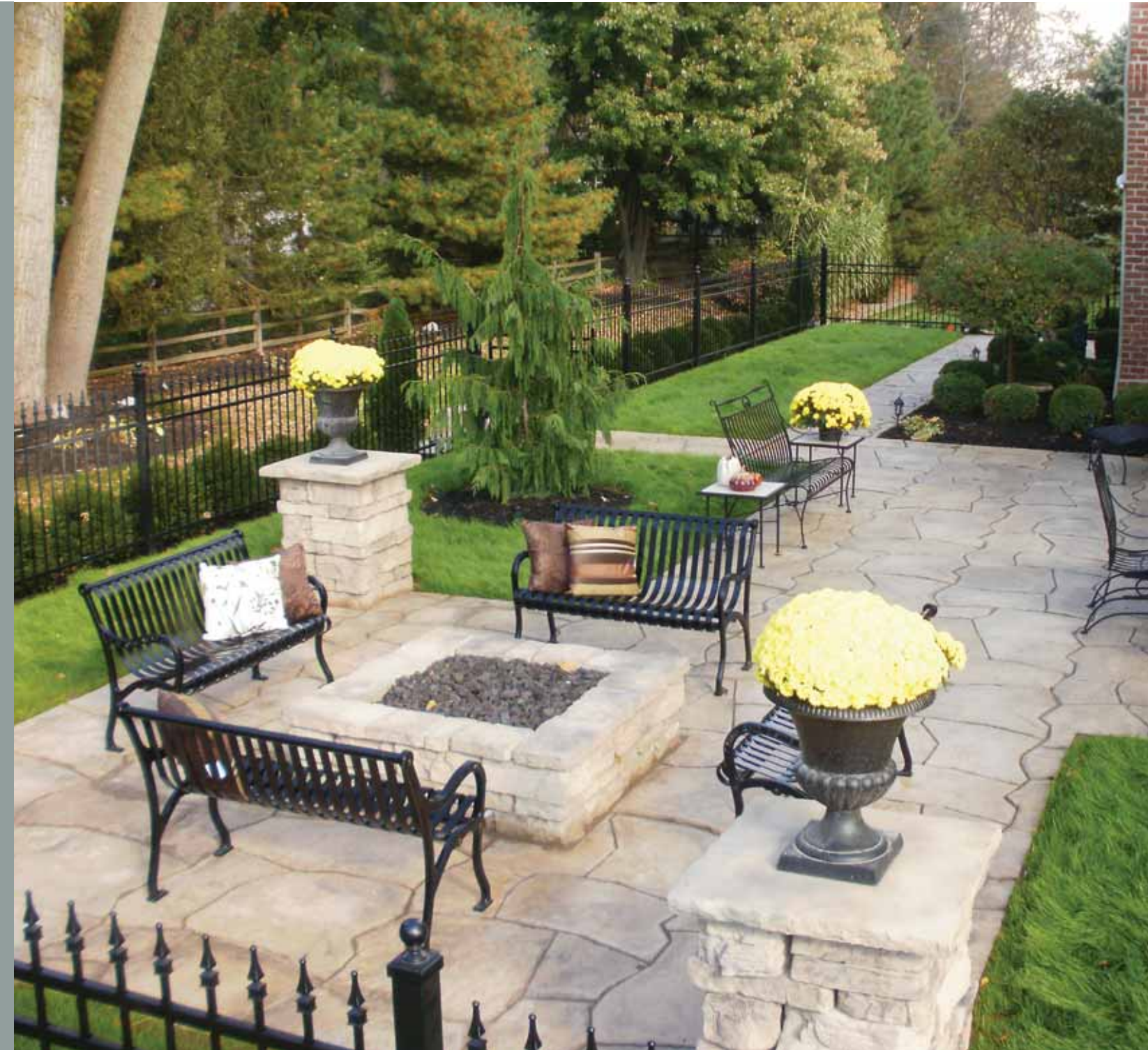

©2011 Oberfields





OBERFIELDS INTERLOCKING CONCRETE PAVER AND RETAINING WALLS WARRANTY

Oberfields is proud to inform you that all of its interlocking concrete pavers and retaining walls meet or exceed the requirements of ASTM C-936 for pavers and ASTM C-1372 for walls.

Subject to the conditions below, Oberfields provides a limited lifetime warranty of its paver, dry cast wall products, and Rosetta family of precast products against manufacturing defects for as long as you own your home! This Warranty is provided to the original purchaser only, with the original proof of purchase, and is non-transferable. It is recommended that a certified contractor, who guarantees their workmanship for 2 years, install all Oberfields Hardscape products.

This Warranty expressly excludes damage resulting from misuse, abuse, improper installation, abnormal use, efflorescence, indentations customary to manufacturing, chemical action, faulty design, splitting, chipping, and other damage that could be caused by impact, abrasion, or overloading. This Warranty applies only to material that fails to meet the requirements of ASTM C-936 for pavers and ASTM C-1372 for walls, and is only valid if the material is installed under the guidelines of ICPI (www.icpi.org), NCMA (www.ncma.org), or Oberfields installation guideline manual. This Warranty is for residential construction only. Your exclusive remedy for any defective material and Oberfields sole obligation hereunder is limited to the replacement of defective material at no charge. Oberfields is not responsible for any shipping cost or costs relating to removal of defective material and replacement labor.

OBERFIELDS WARRANTY AS STATED HEREIN IS IN LIEU OF ALL OTHER WARRANTIES OR GUARANTEES, EXPRESS OR IMPLIED, OF ANY NATURE WHATSOEVER, INCLUDING, WITHOUT LIMITATION, ANY IMPLIED WARRANTY OF MERCHANTABILITY OR FITNESS FOR A PARTICULAR PURPOSE. IN NO EVENT SHALL OBERFIELDS BE LIABLE FOR ANY LOSS OR DAMAGE ARISING DIRECTLY OR INDIRECTLY FROM THE USE OF ITS MATERIAL OR FOR CONSEQUENTIAL OR INCIDENTAL DAMAGES, WHETHER BASED IN CONTRACT, TORT, OR ANY OTHER LEGAL THEORY. Exact color, texture, and finish of any replacement materials provided under this Warranty cannot be guaranteed to match the original material. The original purchaser agrees to defend, indemnify, and hold harmless Oberfields, Inc. from any claims or liability based upon allegations that any person or entity made additional warranties or representations as to product preference or us.

Limitation of Liability: *Oberfields Entire Liability for any defective material shall in no event exceed the original purchase price of the defective material. This limitation applies even if Oberfields cannot or does not replace any defective material.*

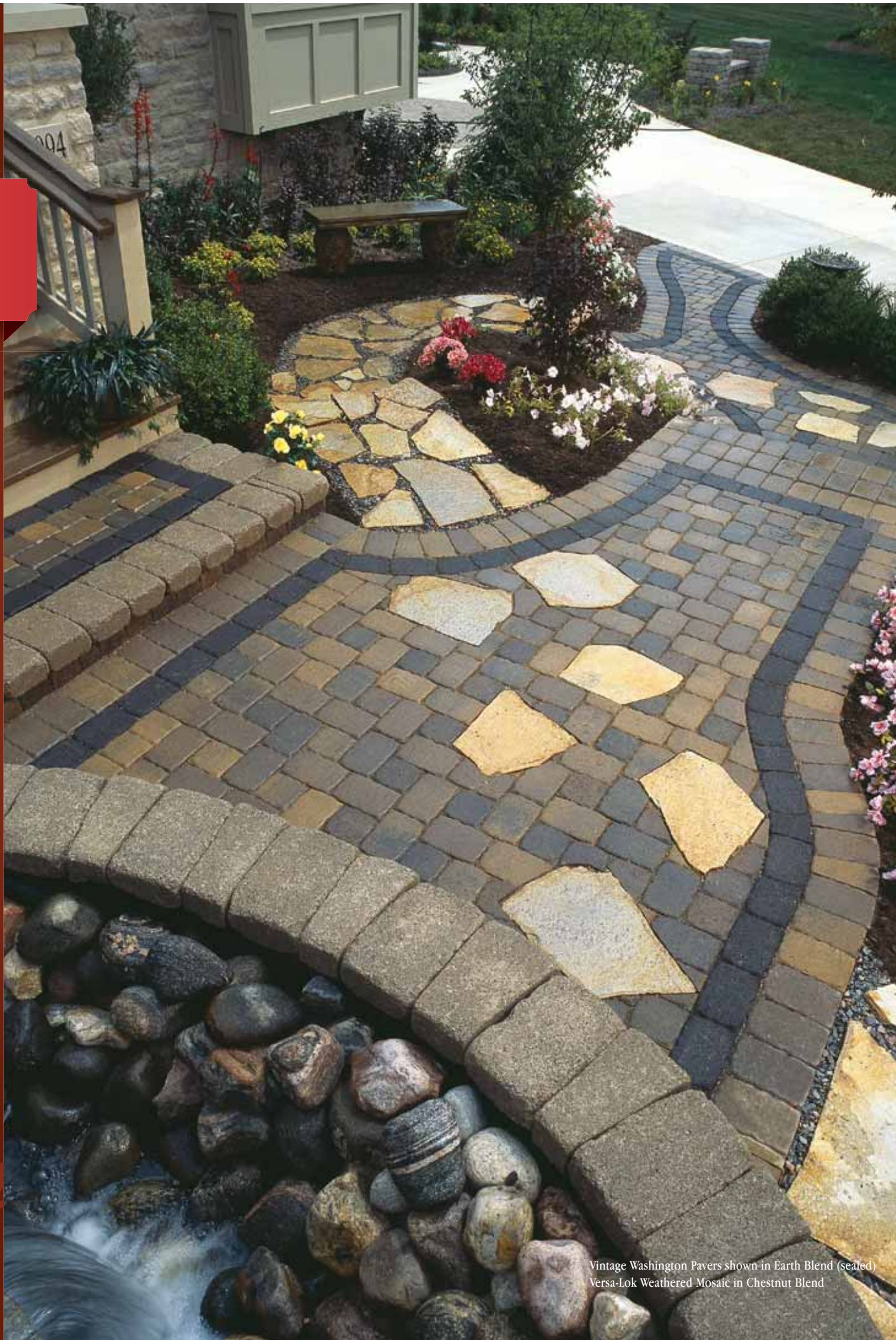

Vintage Washington Pavers shown in Earth Blend (seated)
Versa-Lok Weathered Mosaic in Chestnut Blend

Index

RESIDENTIAL	
Walkways/Patios.....	2
Driveways	3
Steps & Stairways	4
Fire Pits & Grills	5
Water Features	6
Columns & Borders	7
Monroe Pavers	8-9
Washington Pavers	10-11
Washington Circle Pavers	12-13
Vintage Washington Pavers	14-15
Vintage Belhaven® Pavers	16-17
Vintage Richfield® Pavers	18-19
Grand Flagstone	20-21
StoneTile	22-23
Turfstone® & Monoslab®	24
Permeable Pavers	25
Patio Stones & Edging	26
Custom Concrete Countertops	27
Paver Installation/Checklist	28-29
Non-Weathered Versa-Lok® Walls	30-31
Non-Weathered Versa-Lok® Mosaic® Walls	32-33
Weathered Versa-Lok® Mosaic® Walls	34-35
Omega Wall System.....	36-37
Edington™ Wall Stone	38-39
Rosetta® Belvedere	40-41
Rosetta® Outcropping.....	42-43
Rosetta® Steps	44
Handy Wall®	45
Retaining Wall Installation	46
COMMERCIAL	
Washington Pavers & Circle Pavers	48
ADA Pavers	49
Vintage Pavers	50
Edington™ Wall Stone	51
Monroe Pavers/Lincoln Pavers	52
Versa-Lok® Segmental Retaining Walls	53
Weathered Versa-Lok® Mosaic® Retaining Walls....	54
GENERAL INFORMATION	
Emberlok Masonry Fireplace System	55
Installation Recommendations	56
Estimating	57
Design Elements	58-59
Packaging Information	60-61





Vintage Belhaven pavers in Earth Blend
Edington™ Wall Stone in Brownstone*

Washington Pavers in Flagstone Blend w/ Charcoal Border

Vintage Washington Circle & Pavers in Earth Blend
Weathered Versa-Lok® Mosaic® Walls in Chestnut Blend

The outside of your home speaks a lot about who you are and how you live.
A welcoming walkway is like extending a warm handshake to an old friend.
An inviting patio beckons friends and family to stay a little longer and catch
up with each other.

Inviting

WALKWAYS & PATIOS



Vintage Belhaven® Pavers in Earth Blend (sealed)



Washington Pavers in Albany Blend (sealed)



Washington Pavers in Flagstone Blend



Washington Pavers in Earth Blend



Nothing adds more curb appeal than a driveway with the classic shapes and colors of Oberfields concrete pavers. Attractive. Durable. Practical. Oberfields line of pavers are just the right fit for driveway applications. No sealing or patching here.

Welcoming

DRIVEWAYS



Non-Weathered Versa-Lok® in Antique



Weathered Versa-Lok® Caps in Earth Blend



Weathered Versa-Lok® Mosaic in Chestnut Blend

Gone are the days of incorporating steps only out of necessity. Create various elevations in your patio or walkway by adding wide inviting steps into your hardscape plan. By using our pavers or retaining wall units as steps, it's a perfect solution to form and function.

Cascading

STEPS & STAIRWAYS

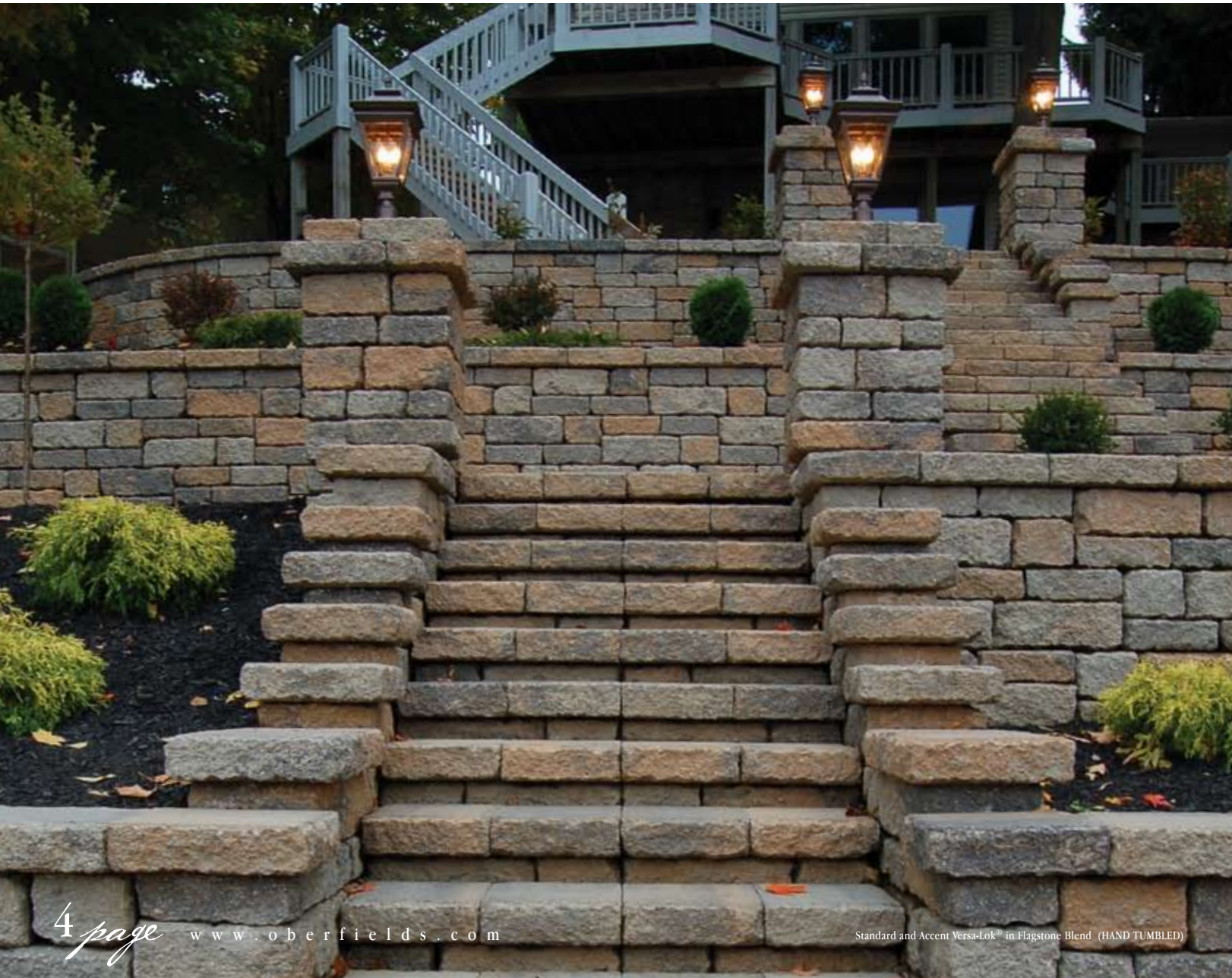

Standard and Accent Versa-Lok® in Flagstone Blend (HAND TUMBLED)



Vintage Belhaven® Pavers in Earth Blend (sealed)
Edington™ Wall Stone in Earth Blend



Edington™ Wedge in Flagstone Blend



Edington™ Wall Stone in Earth Blend
Oberfield's Concrete Countertop in Black & Tan



Weathered Versa-Lok Mosaic in Flagstone Blend

Blazing

FIRE PITS & GRILLS

Outdoor fire pits and kitchens can help take your patio from ordinary to extraordinary. You'll get more use out of your patio for entertaining and to warm up on cool evenings when you use Oberfields retaining wall products to create fire pits, grill surrounds and to define kitchen areas.



Edington™ Wall Stone in Earth Blend



Edington™ Wall Stone in Earth Blend



Rosetta® Outcropping Wall Stone shown in Cuyahoga Non-Weathered Versa-Lok® shown in Flagstone Blend

Add the sound of water to your outdoor living space. A natural looking water feature incorporated into your patio can add just the right dramatic element for a calm, relaxing experience. Light your water feature to add extra ambiance.

Dramatic

WATER FEATURES



Rosetta™ Wall Stone Retaining Walls
Photo Supplied by Rosetta



Edington™ Wall Stone in Flagstone Blend,
Washington Pavers in Flagstone Blend, Rockface Pier Caps in Gray



Edington™ Wall Stone in Earth Blend
Vintage Belhaven® Pavers in Earth Blend (sealed)



Vintage Washington Circle in Earth Blend



Vintage Belhaven® Pavers in Earth Blend (sealed)

Be creative when planning your patio. Add a border to your patio in a contrasting color, incorporate curves into a sidewalk, pay close attention to detail on your columns. Oberfields offers column pier caps in a variety of finishes, numerous color and size options of pavers to help define a space, and many sealers and enhancers to add that special touch to your patio.

Defining

COLUMNS & BORDERS

Versatile Beauty

THE MONROE SYSTEM®



The classic straight lines our Monroe System® pavers allow the homeowner, that prefers the traditional brick look, the freedom to choose from various colors and a variety of patterns from simple to complex.

Monroe Pavers shown in Flagstone Blend
Non-Weathered Versa-Lok® in Flagstone Blend

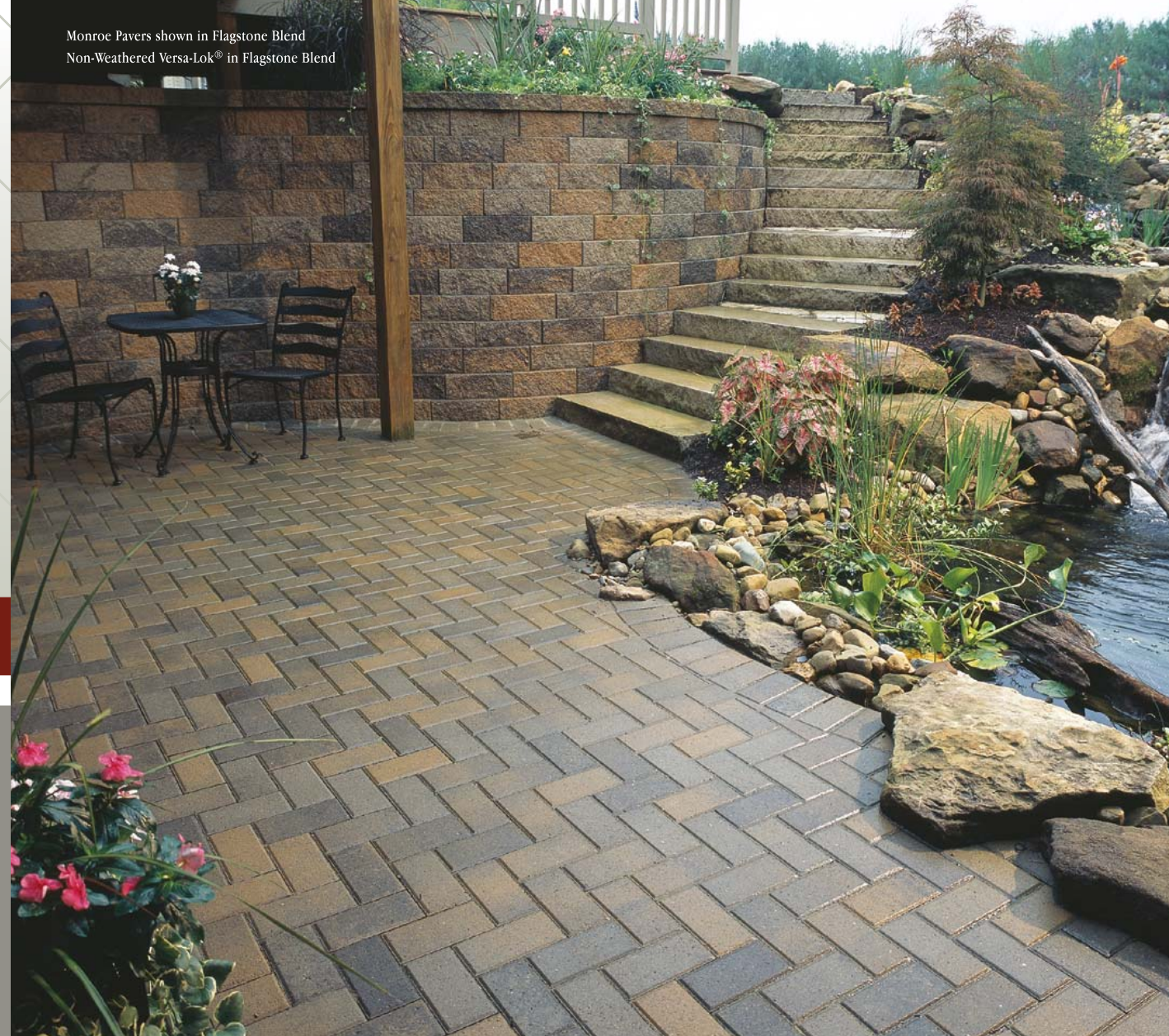

Monroe Pavers shown in Antique Blend
Edington™ Wall Stone Wall shown in Fieldstone & Quarystone



Monroe Pavers shown in Albany Blend



Monroe Pavers shown in Albany Blend

- 1) Monroe— 4" x 8" (100mm x 200 mm)
- 2) Monroe 4* — 4" x 8" (100mm x 200 mm)
-Center score creates look of 4"x4" pavers
- 3) Monroe 8* — 8" x 8" (200mm x 200 mm)
- 4) Monroe 12* — 12" x 12" (300mm x 300 mm)

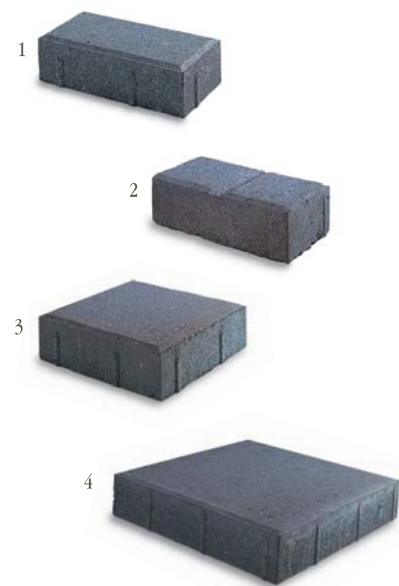

All stocked Monroe pavers are 2³/₈" thick (60 mm)
Monroe Pavers also available 3¹/₈" thick (80 mm)

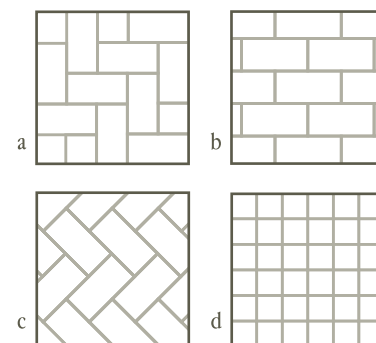

- Installation Patterns:
- a) 90° Herringbone
 - b) Running Bond
 - c) 45° Herringbone
 - d) Monroe 8, or 12

There are numerous pattern options using different sizes of pavers.

Stocked Monroe (Monroe 4" x 8" shape only) Colors:



Custom colors available upon request.

All paver color swatches on this page are shown sealed.

Due to variations in printing, all color selections should always be chosen from actual product samples.

Above colors are stocked in shape 1 only (see page 8).



Washington Pavers shown in Antique Blend



Washington Pavers shown in Flagstone Blend
Versa-Lok® Weathered Mosaic shown in Flagstone Blend



Washington Pavers shown in Earth Blend



Washington Pavers shown in Antique Blend
Edington™ Wall Stone shown in Fieldstone and Quarrystone Mixed



Washington Pavers shown in Antique Blend

Old World Charm

THE WASHINGTON SYSTEM®



Classic cobblestone circles and numerous patterns with squares and rectangles offer the European charm that make our Washington pavers among the most classic landscape enhancements.

1) Washington 10 – 4¹/₈" x 5¹/₂" (105 mm x 140 mm)

2) Washington 14 – 5¹/₂" x 5¹/₂" (140 mm x 140 mm)

3) Washington 21 – 5¹/₂" x 8¹/₄" (140 mm x 210 mm)

All stocked Washington Pavers are 2³/₈" thick (60 mm)

Washington 14 & 21 Pavers also available 3¹/₈" thick (80 mm)

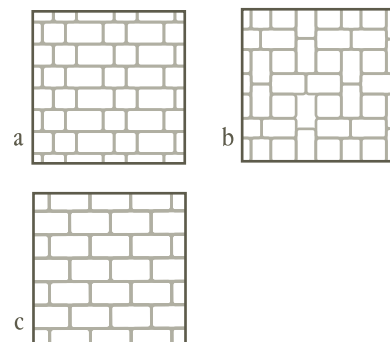
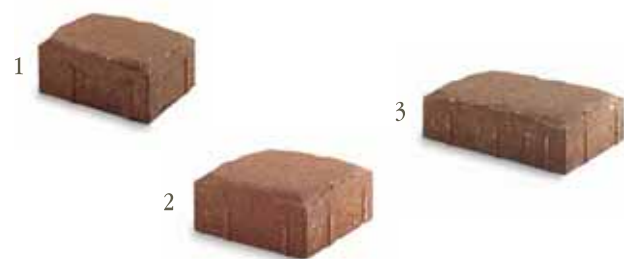

- a) Muster D (40% Wash. 14/60% Wash. 21)
- b) Muster K (28% Wash. 14/72% Wash. 21)
- c) Running Bond 10, 14, or 21

There are numerous pattern options using different sizes of pavers.

Stocked Washington Colors:



Albany Blend



Antique Blend



Autumn Blend



Canyon Creek Blend

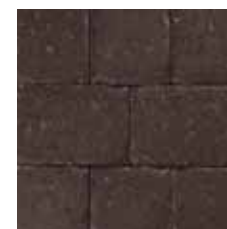

Charcoal



Earth Blend



Flagstone Blend



Granite Blend

Custom colors available upon request.

All paver color swatches on this page are shown sealed.

Due to variations in printing, all color selections should always be chosen from actual product samples.



Radiating Style

THE WASHINGTON CIRCLE PAVERS®



Washington Circle Pavers shown in Earth Blend
Edington™ Wall Stone shown in Fieldstone



Vintage Washington Circle Pavers shown in Earth Blend
Edington Firepit shown in Earthstone and Quarystone



Washington Circle Pavers shown in Earth Blend
Edington™ Wall Stone shown in Fieldstone and Quarystone

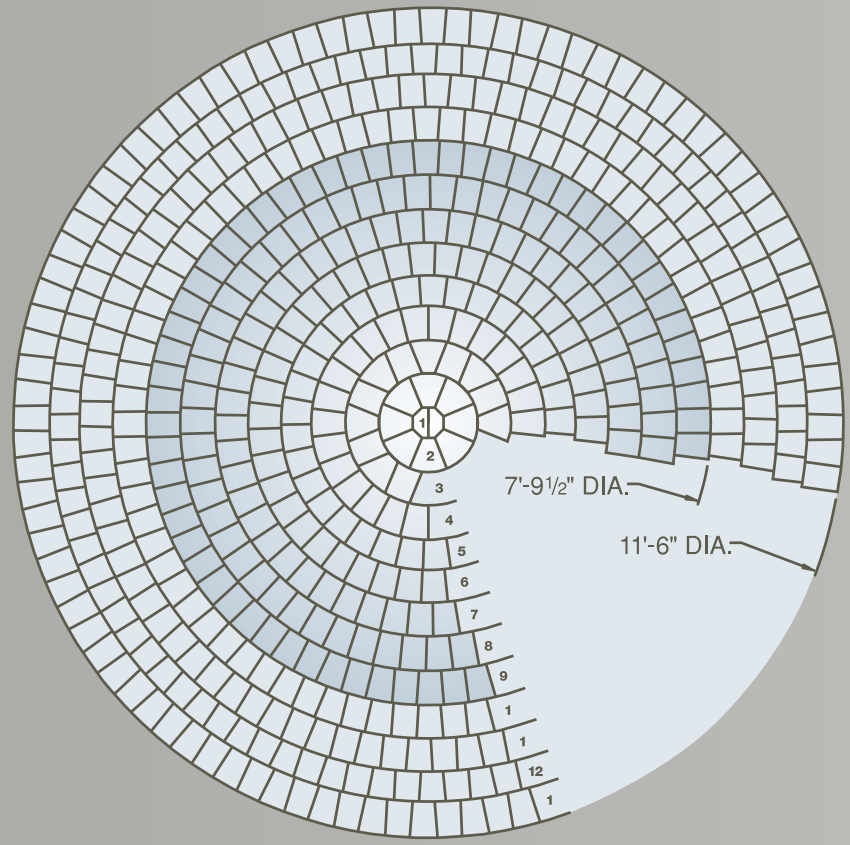

	Row	Circle Diameter	Installation Pattern	Paver Description - Washington Series
First Circle Pack	1	5 1/2"	Single	2-Washington Circle Center
	2	16 1/2"	Single	8-Washington Small Circle
	3	27 1/2"	Alternate	8-Washington Small Circle & 8-Washington 10
	4	38 1/2"	Single	26-Washington Large Circle
	5	49 1/2"	Single	33-Washington Large Circle
	6	60 1/2"	Single	42-Washington Large Circle
	7	71 1/2"	Alternate	25-Washington Large Circle & 25-Washington 10
	8	82 1/2"	Alternate	29-Washington Large Circle & 29-Washington 10
	9	93 1/2"	Alternate	34-Washington Large Circle & 34 Washington 10
Second Circle Pack	10	104 1/2"	Alternate	38-Washington Large Circle & 38 Washington 10
	11	115 1/2"	Alternate	42-Washington Large Circle & 42 Washington 10
	12	127"	Alternate	46-Washington Large Circle & 46 Washington 10
	13	138"	Alternate	50-Washington Large Circle & 50 Washington 10
Additional Pieces	14 & up		Single	(As Needed) Washington 10 (81 pcs or 12.78 ft ² per pallet band)
Notes	Due to the complex shapes of the pieces in a circle, there will be some extra pieces not used for standard installation. As shown above, additional pieces may be needed for diameters larger than 8'. Oberfields Edington Wedge Firepit Kit fits at 5th row, for installation, omit rows 1-5			

- 1) Washington Circle System—Circle center, small circle paver, large circle paver
 - 2) Washington 10 —4 1/8" x 5 1/2" (105 mm x 140 mm)
- All Washington Circle Pavers are 2 3/8" thick (60 mm)



Stocked Washington Circle Colors:



Custom colors available upon request.
All paver color swatches on this page are shown sealed.
Due to variations in printing, all color selections should always be chosen from actual product samples.

Lasting Memories

VINTAGE WASHINGTON PAVERS®



Oberfields Vintage Paving Stones offer classic good looks that never go out of style or wear out. Our Vintage Paving Stones are tumbled pavers that create a rustic, weathered appearance. A combination of large and small paving stones allows you to capture striking arrangements of circles, steps and elevations to artfully accent your landscape. This elite collection of tumbled concrete pavers offers you a rich palette of colors, textures, shapes and sizes crafted for state-of-the-art resilience and maintenance-free performance.

- 1) Vintage Washington 10 -4 1/8" x 5 1/2" (105 mm x 140 mm)
 - 2) Vintage Washington 14 -5 1/2" x 5 1/2" (140 mm x 140 mm)
 - 3) Vintage Washington 21 -5 1/2" x 8 1/4" (140 mm x 210 mm)
- All stocked Vintage Washington Pavers are 2 3/8" thick (60 mm)
Vintage Washington 14 & 21 Pavers also available 3 1/8" thick (80 mm)



- 4) Washington 10 -4 1/8" x 5 1/2" (105 mm x 140 mm)
- 5) Vintage Washington Circle - Circle center, small circle paver, large circle paver - See page 13 for circle diagram



- a) Muster D (40% Wash. 14/60% Wash. 21)
- b) Muster K (28% Wash. 14/72% Wash. 21)
- c) Running Bond 10, 14, or 21

There are numerous pattern options using different sizes of pavers.
All paver color swatches on this page are shown sealed.
Due to variations in printing, all color selections should always be chosen from actual product samples.

Stocked Vintage Washington Colors:



Vintage Autumn Blend Vintage Canyon Creek Blend Vintage Earth Blend



Vintage Flagstone Blend Vintage Granite Blend

Custom colors available upon request.

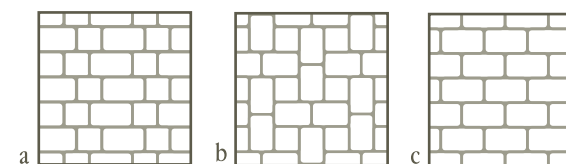

Vintage Washington Pavers shown in Earth Blend
Edgington™ Wall Stone shown in Fieldstone & Quarystone



Vintage Washington Pavers shown in Charcoal w/ Flagstone border



Vintage Belhaven® Pavers shown in Flagstone Blend (sealed)

Vintage Belhaven® Pavers shown in Earth Blend

Supreme Distinction

VINTAGE BELHAVEN® PAVERS



Vintage Belhaven® Pavers are our premium concrete paver line that incorporates the rustic, weathered appearance of cobblestones with the versatility of various sizes and textures. Belhaven® Pavers are a collection of six various size pavers that have a weathered surface enhanced by slightly chiseled edges. Its many modular sizes make it easy to create unique and interesting patterns for any application.



Vintage Belhaven® Pavers shown in Earth Blend (sealed)
Edington™ Wall Stone shown in Earth Blend

- 1) Vintage Belhaven® Small Square – 5 1/2" x 5 1/2" (140 mm x 140 mm)
- 2) Vintage Belhaven® Large Square – 11" x 11" (280 mm x 280 mm)
- 3) Vintage Belhaven® Small Rectangle – 5 1/2" x 2 3/4" (140 mm x 70 mm)
- 4) Vintage Belhaven® Standard Rectangle – 8 1/4" x 5 1/2" (210 mm x 140 mm)
- 5) Vintage Belhaven® Large Rectangle – 11" x 8 1/4" (280 mm x 210 mm)
- 6) Vintage Belhaven® Jumbo Rectangle – 16 1/2" x 11" (420 mm x 280 mm)

All Belhaven® pavers are 2 3/4" thick (70 mm).

Bluestone stocked in select sizes only.

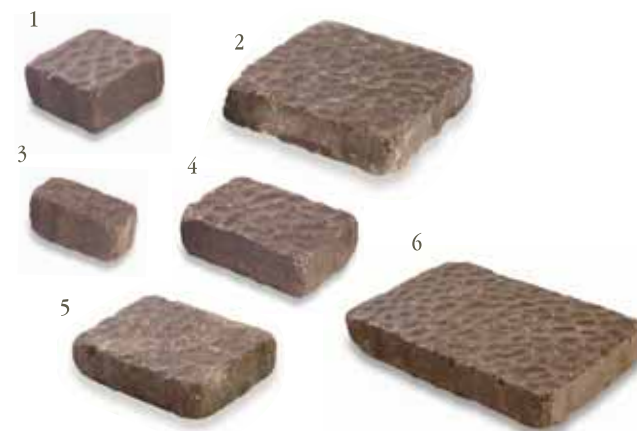

7) Belhaven® Circle System – Circle Center, Small Circle Paver, Large Circle Paver and Rectangle Circle Paver.

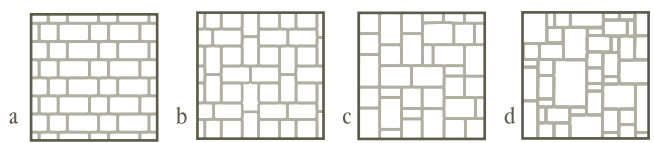

- a) Muster D (40% Small Sq./60% Standard Rec.)
- b) Muster K (28% Small Sq./72% Standard Rec.)
- c) 3 Piece Random Pattern (51% Standard Rec./11% Small Rec./38% Small Sq.)
- d) 6 Piece Random Pattern (29% Jumbo Rec./17% Large Rec./18% Standard Rec./7% Small Rec./18% Large Sq./11% Small Sq.)

Stocked Belhaven® Colors:



Bluestone is only available for the Small Rectangle, Small Square, and Std. Rectangle. Custom colors available upon request.

Due to variations in printing, all color selections should always be chosen from actual product samples.

BELHAVEN® PAVERS

Circle Diagram

	Row	Circle Diameter	Installation Pattern	Paver Description - Belhaven Series
Circle Pack	1	5 1/2"	Single	1-Belhaven Circle Center
	2	16 1/2"	Single	8-Belhaven Small Circle
	3	27 1/2"	Alternate	8-Belhaven Small Circle & 8-Belhaven Rectangle Paver
	4	38 1/2"	Single	26-Belhaven Large Circle
	5	49 1/2"	Single	33-Belhaven Large Circle
	6	60 1/2"	Single	42-Belhaven Large Circle
	7	71 1/2"	Alternate	25-Belhaven Large Circle & 25-Belhaven Rectangle Paver
	8	82 1/2"	Alternate	29-Belhaven Large Circle & 29-Belhaven Rectangle Paver
	9	93 1/2"	Alternate	34-Belhaven Large Circle & 34-Belhaven Rectangle Paver
	10	104 1/2"	Alternate	38-Belhaven Large Circle & 38-Belhaven Rectangle Paver
	11	115 1/2"	Alternate	42-Belhaven Large Circle & 42-Belhaven Rectangle Paver
	12	127"	Alternate	46-Belhaven Large Circle & 46-Belhaven Rectangle Paver
	13	138"	Alternate	50-Belhaven Large Circle & 50-Belhaven Rectangle Paver
Additional Pieces	14 & up		Single	(As Needed) Belhaven Small Square Paver
Notes	Due to the complex shapes of the pieces in a circle, there will be some extra pieces not used for standard installation. Oberfields Edington Wedge Firepit Kit fits at 5th row, for installation, omit rows 1-5			

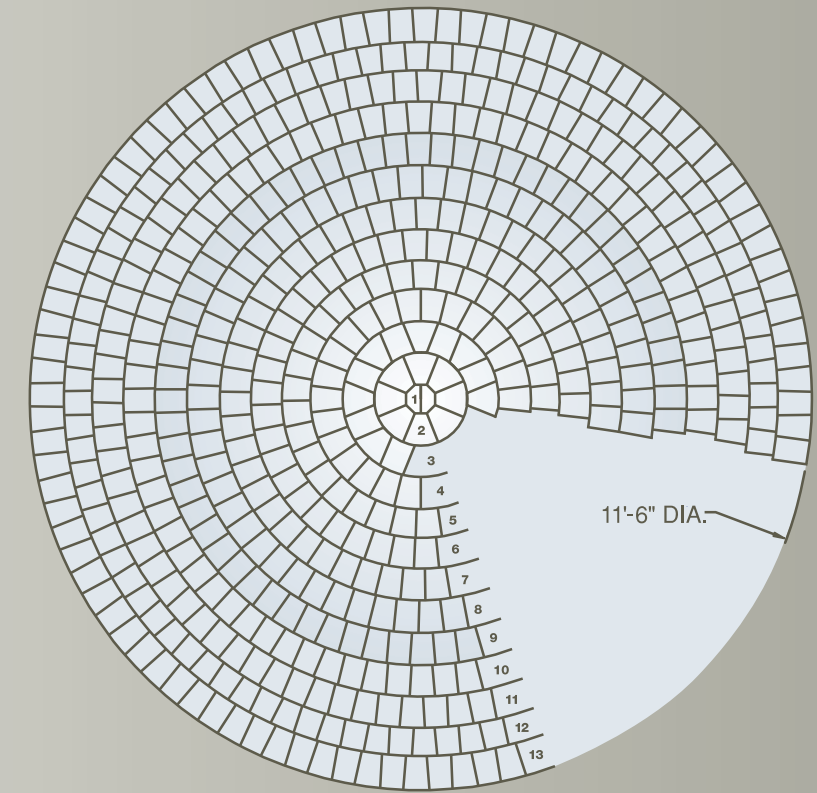

Historic Charm

VINTAGE RICHFIELD® PAVERS

Vintage Richfield® Pavers are a twist off of our Vintage Belhaven® Series Pavers. Available in three sizes, the Vintage Richfield® Pavers have a non-dimpled texture and can be used to create unique and interesting patterns for any application.



Vintage Richfield® pavers shown in Earth Blend

- 1) Vintage Richfield® Small Square – 5 1/2" x 5 1/2" (140 mm x 140 mm)
- 2) Vintage Richfield® Standard Rectangle – 8 1/4" x 5 1/2" (210 mm x 140 mm)
- 3) Vintage Richfield® Large Rectangle – 11" x 8 1/4" (280 mm x 210 mm)

All Vintage Richfield® pavers are 2 3/4" thick (70 mm)



Stocked Vintage Richfield® Colors:



Earth Blend



Flagstone Blend

Custom colors available upon request.

Due to variations in printing, all color selections should always be chosen from actual product samples.

Installation Patterns:

- a) 3 Piece Random Pattern (51% Standard Rec./11% Large Rec./38% Small Sq.)
- b) Muster D (40% Small Sq./60% Standard Rec.)
- c) Muster K (28% Small Sq./72% Standard Rec.)
- d) Running Bond (Small Sq., Standard Rec. or Large Rec.)

There are numerous pattern options using different sizes of pavers.

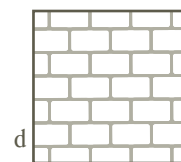
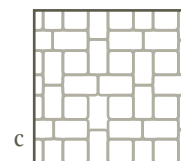
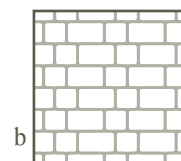
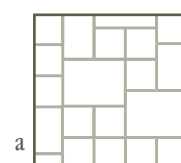

Vintage Richfield® pavers shown in Earth Blend



Vintage Richfield® pavers shown in Earth Blend

Grand Impressions

ROSETTA GRAND FLAGSTONE



Large natural flagstones have been a highly sought-after building material for patios and walkways for generations. Although these stones are very attractive, they can be difficult to fit together because they vary in thickness and size, making for an uneven, gapped surface when installed.

Grand Flagstone maintains the attractive texture and scale of large natural flagstone, but can be laid in an easy-to-install pattern. Additionally, the unit thicknesses are consistent, making for a comfortable, quality finished installation. Grand Flagstone is a perfect fit for patios, pathways, pool decks, outdoor kitchens and more. For a project that deserves natural sophistication, Grand Flagstone provides the solution you're looking for.

- Beautiful natural stone texture.
- 15 unique shapes replicate large, irregular flagstone.
- Fast installation with easy-to-install pattern.
- Uniform thickness (1.75") = comfortable end result.
- High strength concrete = long term durability.
- Multiple natural color blends available.

Rosetta® Grand Flagstone Colors:



Cuyahoga

Due to variations in printing, all color selections should always be chosen from actual product samples.

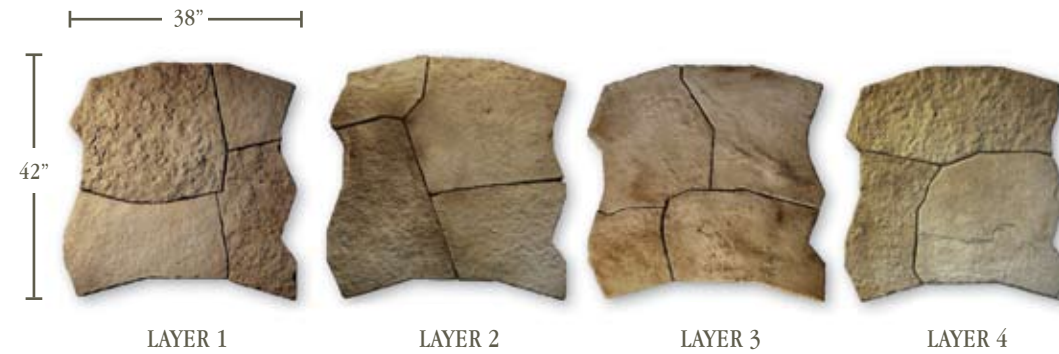

PATIO LAYOUT

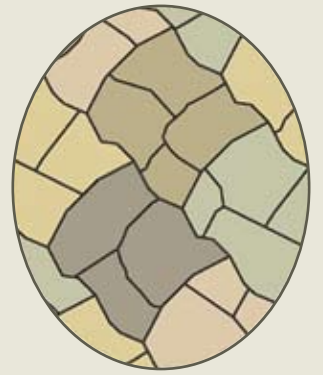

WALKWAY LAYOUT

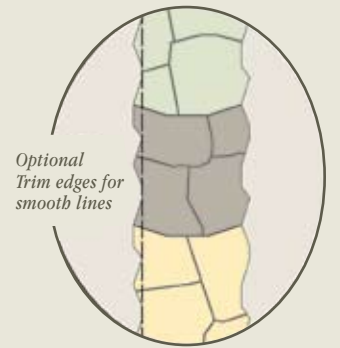

Grand Flagstone shown in Cuyahoga



Flagstone shown in Cuyahoga Blend

Sophisticated Style

STONETILE



For natural stone elegance with European flair, StoneTile Tuscanni blends natural stone appearance with sophisticated style. Create distinctive textured patterns with the irregular, ridged surface.

StoneTile Abruzzo emulates the charming village and scenic country villas built during the Renaissance, with an authentically random surface texture.



StoneTile Tuscanni in Roccia Blu



StoneTile Abruzzo in Caramel Ferrous

StoneTile Abruzzo

- 1) 300 x 300 Module* – 41/2" x 9" x 31/8" (114 mm x 229 mm x 80 mm)
- 2) 300 x 450 Module* – 11.81" x 17.72" x 2.36" (300 mm x 450 mm x 60 mm)
- 3) 400 x 400 Module – 15.75" x 15.75" x 1.57" (400 mm x 400 mm x 40 mm)
- 4) 400 x 600 Module – 15.75" x 23.62" x 1.57" (400 mm x 600 mm x 40 mm)
- 5) 600 x 600 Module* – 23.62" x 23.62" x 1.57" (600 mm x 600 mm x 40 mm)

Stocked in 15.75" x 15.75" and 15.75" x 23.62"



Stocked StoneTile Abruzzo Colors:



Caramel Ferrous

StoneTile Tuscanni

- 1) 300 x 300 Module* – 41/2" x 9" x 31/8" (114 mm x 229 mm x 80 mm)
- 2) 300 x 450 Module* – 11.81" x 17.72" x 2.36" (300 mm x 450 mm x 60 mm)
- 3) 400 x 400 Module – 15.75" x 15.75" x 1.57" (400 mm x 400 mm x 40 mm)
- 4) 400 x 600 Module – 15.75" x 23.62" x 1.57" (400 mm x 600 mm x 40 mm)
- 5) 600 x 600 Module* – 23.62" x 23.62" x 1.57" (600 mm x 600 mm x 40 mm)

Stoked in 15.75" x 15.75" and 15.75" x 23.62"

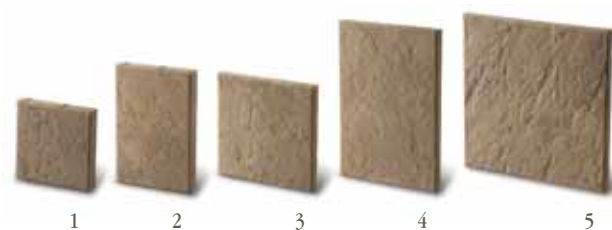

Stocked StoneTile Tuscanni Colors:

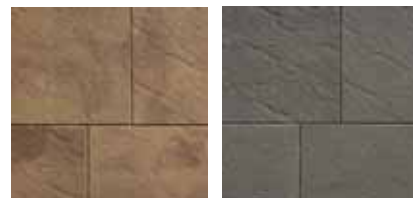

Cappuccino

Roccia Blu

Custom colors available upon request.

Due to variations in printing, all color selections should always be chosen from actual product samples.



StoneTile Tuscanni in Cappuccino



StoneTile Tuscanni in Roccia Blu

Installation Patterns:

- a) Running Bond (100% 16" x 16" or (100% 16" x 24"))
- b) Modified Finish Running Bond (40% 16" x 16" / 60% 16" x 24") or (40% 12" x 12" / 75% 12" x 18")
- c) Modified Herringbone (25% 16" x 16" / 75% 16" x 24") or 25% 12" x 12" / 75% 12" x 18")
- d) Modified Finish Running Bond (40% 16" x 24" / 60% 24" x 24")

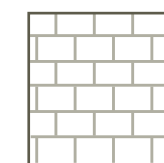

a

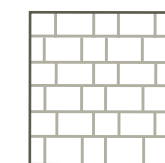

b

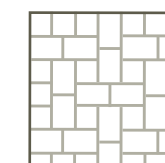

c

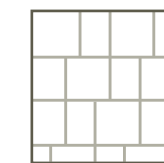

d

There are numerous pattern options using different sizes of pavers.

Reveal Your Greens

TURFSTONE® & MONOSLAB® PAVERS

Eco Friendly Solutions

WASHINGTON 21® PERMEABLE PAVERS



Monoslab® Grass Paver Shown in Gray



Turfstone® Grass Paver Shown in Gray

Preserve your lawn in areas that may double as parking or driveways with a concrete grid system that keeps the green while providing solid erosion control and good drainage.

Permeable Interlocking Concrete Pavements are comprised of a layer of concrete pavers separated by joints filled with small stones. Water enters joints between solid concrete pavers and flows through an "open-graded" base, i.e. crushed stone layers with no small or fine particles. The void spaces among the the crushed stones store water and infiltrate it back into the soil sub grade. The stones in the joints provide 100% surface permeability and the base filters storm water and reduces pollutants.

Permeable Interlocking Concrete Pavers (PICPs) are eligible for LEED® credits under the U.S. Green Building Councils guidelines. These requirements limit runoff and water pollution by managing storm water. These pavements can reduce runoff-generating impervious cover and decrease the rate and quantity of runoff.

From the same family as our best-selling Washington Series® pavers, our new Washington 21® Permeable Pavers have been designed as a solution to storm water drainage and groundwater recharge.

The design of the Washington 21® Permeable Paver allows water to flow around and through the paver joints effortlessly. The design is dynamic enough to also allow these units to be used in conjunction, seamlessly with our standard Washington® System allowing for flexible design between permeable and non-permeable areas in the same design.



1) Turfstone® Grass Paver - 15⁵/₈" x 23⁵/₈" x 3¹/₈" (400 mm x 600 mm x 80 mm)

2) * Monoslab® Grass Paver - (Non-Stock) 15⁵/₈" x 23¹/₂" x 4¹/₂" (397 mm x 597 mm x 114 mm)



1) Vintage Washington Full and Half Permeable Pavers*

Full 5¹/₂" x 8¹/₄" (140 mm x 210 mm), Half 5¹/₂" x 4¹/₈" (140 mm x 105 mm)

2) Washington Full and Half Permeable Paver*

Full 5¹/₂" x 8¹/₄" (140 mm x 210 mm), Half 5¹/₂" x 4¹/₈" (140 mm x 105 mm)

Available in non-tumbled or vintage textures



Optional Permeable Colors: (non-stocked)



Albany Blend



Antique Blend



Autumn Blend



Canyon Creek Blend



Charcoal



Earth Blend



Flagstone Blend

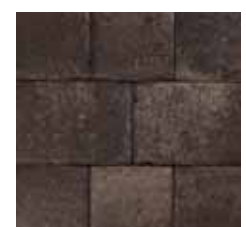

Granite Blend

Custom colors available upon request.

All paver color swatches on this page are shown sealed.

Due to variations in printing, all color selections should always be chosen from actual product samples.



Solid Design Statement

PATIO STONES

CUSTOM CONCRETE COUNTERTOPS

Brick Face
24" x 24"
(Red shown)



Brick Face
18" x 18"
(Gray shown)



Round Patio Stone
12" circle
(Red shown)



Square Patio Stone
Pre-cast 12" x 12"
(Gray shown)



Weathered Edger
15 5/8" (face) x 3 5/8" D
(Gray shown)



Belhaven® Edger Stone
Standard Rectangle – 8 1/4" x 5 1/2"
Large Rectangle – 11" x 8 1/4"
Shapes and sizes will vary
(Earth Blend shown)



Other shapes, colors, and products are available.

Due to variations in printing, all color selections should always be chosen from actual product samples.

Create a truly custom art form that's designed to meet your design aesthetic. Oberfield's concrete countertops integrate your tastes, your ideas, your personality into things once thought as having only limited options.



Custom Concrete Countertop shown in Black & Tan



Custom Concrete Countertop shown in Black and Tan



Custom Concrete Countertop shown in Black and Tan

Custom Concrete Countertop Colors:



Custom colors available upon request.

Due to variations in printing, all color selections should always be chosen from actual product samples.

Edge Details:

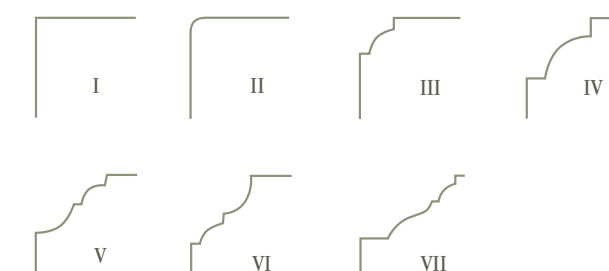

These are the basics for a successful installation. Additional questions can be answered by calling Oberfields directly or by your local Oberfields paver distributor.



Step By Step

PAVER INSTALLATION



*Photographs are property of Interlocking Concrete Pavement Institute.

1. EXCAVATION/BASE

If you're installing a walkway or patio, you will need to remove a 4" to 6" depth of soil below your intended surface. For driveways and other heavy-duty applications, you will need an 8" to 10" depth. In moist or wet areas, lay down a geotextile fabric before compacting your base material of 3/4" stone with fines compacted in 3" lifts. Level to required grade, allowing room for setting bed.

2. SETTING BED

Cover top of the compacted base with 1" to 1 1/2" of concrete sand. Level sand in narrow areas by pulling a 2" x 4" board, notched to give the proper depth, across the top of the plastic edging. To level wide areas, use a 2" x 4" board on top of parallel 1" diameter pipes.

3. PAVER INSTALLATION

Place Presidential Series® pavers in your desired pattern. Select pavers vertically from multiple cubes for optimum color blending. Use a concrete saw to cut odd-shaped pieces within your design. Use string lines to assure a straight layout. Spacing between pavers should not exceed 1/8".

4. EDGE RESTRAINT

Plastic edge restraints are ideal for laying out the borders of your design. Lay edging directly on stone base and secure with 12" landscape spikes. Use spikes every two feet for straight walkway and patio edges, every one foot for curves and driveways.

5. COMPACTING/SWEEPING

Spread sand over the top of your paver installation and sweep into all joints. The vibrating action of a plate compactor (equipment rental) will force sand between the joints to further stabilize and level the surface. Excess sand should be swept into the joints.

CALCULATING YOUR MATERIALS

Crushed Limestone Base

1 ton covers 200 square feet at 1" deep

Take square footage of area and divide by 200 and then multiply by inches deep

Example: 1000 sq. ft. with base 10" deep
 $1000/200=5$ 5x10" deep = 50 tons

Concrete Setting Bed Sand

Same as above, maximum depth of sand should be 1 1/2" deep

Oberfields is your one-stop source for your project needs.

From aggregate to sealers, Oberfields can provide all materials relating to your projects.

See next page for project checklist



CONSTRUCTION CHECKLIST *This list reviews the construction of interlocking concrete pavements*

JOB PLANNING AND LAYOUT

- Check underground utility locations
- Estimate Excavation
- Estimate: Base Material, Edge Restraints, Sand, Pavers, Edge Pavers
- Plan materials, delivery, flow of materials, and equipment required
- Layout job on site; area to be paved, edges, access, material and equipment storage

SOIL AND BASE

- Excavate soil and unsuitable material
- Compact Soil
- Install drainage and site utilities as applicable
- Plan Base Material
- Measure base Compaction
- Measure base Elevations

SAND

- Check bedding and joint sand gradation
- Place and screed Sand

PAVERS

- Pull or snap lines
- Place edge coursing
- Place laying pattern
- Cut and place edge units
- Compact pavers
- Remove defective units
- Fill joints with sand
- Vibrate/compact joints sand
- Check joints for fullness
- Remove excess sand
- Check surface elevation
- Clean and seal pavers as required
- Clean up site

EDGE RESTRAINT

- Install edge restraints



Non-Weathered Versa-Lok® in Chestnut Blend

Non-Weathered Versa-Lok® in Antique Blend

Non-Weathered Versa-Lok® shown in Earth Blend

Engineered Durability

NON-WEATHERED VERSA-LOK® RETAINING WALLS

When looking for a retaining wall unit that is engineered to retain heavy loads, Versa-Lok's solid unit durability is the perfect fit. Versa-Lok is the only solid, pinned system on the market. It's durable, design friendly, and virtually maintenance free attributes handle the harshest conditions.

1) Versa-Lok® – 16" (face) x 14" (rear) x 12" D x 6" H
(406mm x 355mm x 305mm x 152mm)

2) Rectangular Cap – 15⁵/₈" (face) x 11⁵/₈" D x 3⁵/₈" H
(397 mm x 295 mm x 92mm)



Stocked Non-Weathered Versa-Lok® Colors:



Antique Blend



Buff Blend



Charcoal



Chestnut Blend



Earth Blend



Flagstone Blend



Granite Blend



Gray Blend

Custom colors available upon request.

Due to variations in printing, all color selections should always be chosen from actual product samples.



Non-Weathered Versa-Lok® shown in Flagstone Blend

Endless Possibilities

NON-WEATHERED VERSA-LOK® MOSAIC® retaining wall system



Four different segmental retaining wall options: Standard, Accent, Cobble and Mosaic®. Our Non-Weathered Versa-Lok® Mosaic® Retaining walls can create everything from small, four-foot backyard walls to 40-foot serpentine walls. Use the three sizes together to form the Mosaic® System or separate for three separate unique walls.

Mosaic Configurations



Non-Weathered Versa-Lok® Mosaic® shown in Flagstone Blend



Non-Weathered Versa-Lok® Accents shown in Earth Blend



Non-Weathered Versa-Lok® Mosaic Wall shown in Flagstone Blend w/ weathered cap

- 1) Versa-Lok® Non-Weathered Standard – 16" (face) x 14" (rear) x 12" D x 6" H (406mm x 355mm x 305mm x 152mm)
- 2) Non-Weathered Accent - 12" (face) x 12" D x 4" H (397 mm x 295 mm x 92mm)
- 3) Non-Weathered Cobble - 8" (face) x 12" D x 6" H (397 mm x 295 mm x 92mm)
- 4) Rectangular Cap - 15⁵/₈" (face) x 11⁵/₈" D x 3⁵/₈" H (397 mm x 295 mm x 92mm)

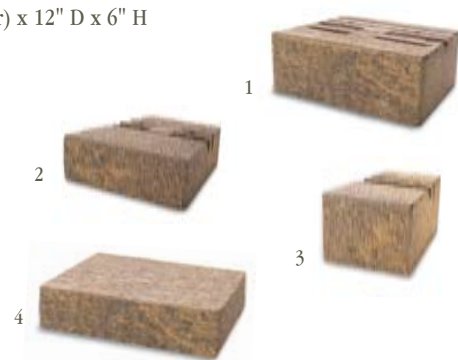

Stocked Non-Weathered Versa-Lok® Colors:



Chestnut Blend

Earth Blend

Flagstone Blend

Granite Blend

Custom colors available upon request.

Due to variations in printing, all color selections should always be chosen from actual product samples.

Age-Old Craftsmanship

WEATHERED VERSA-LOK® MOSAIC® retaining wall system



Recreate the intimate setting of a quaint European countryside right in your own backyard using Weathered Versa-Lok® Mosaic® Retaining Walls. Marvel at the age-old craftsmanship each and every random-patterned Mosaic® wall exudes. Three unique Versa-Lok® units—one Standard, one Cobble, and two Accent—combine to form a Mosaic® wall that's redolent of another age. Dream up and design an endless array of curves, corners and steps using the Mosaic® system.

Mosaic® Installation Configurations:



Weathered Versa-Lok® Mosaic® shown in Chestnut Blend



Vintage Washington Circle & Pavers in Earth Blend
Weathered Versa-Lok® Mosaic® Walls in Chestnut Blend

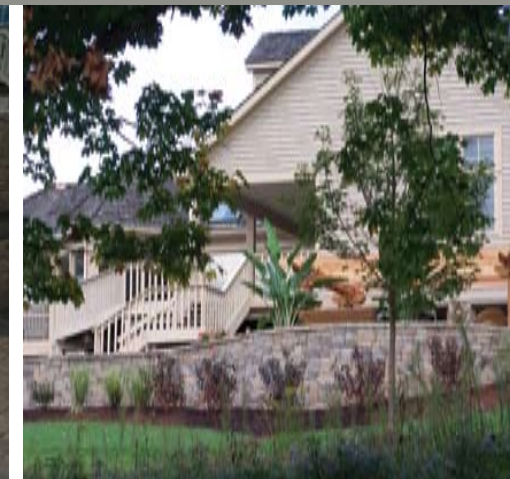

Weathered Versa-Lok® Accents shown in Flagstone Blend



Weathered Versa-Lok® Mosaic® shown in Chestnut Blend

- 1) Versa-Lok® Weathered Standard – 16" (face) x 14" (rear) x 12" D x 6" H (406mm x 355mm x 305mm x 152mm)
- 2) Weathered Accent - 12" (face) x 12" D x 4" H (397 mm x 295 mm x 92mm)
- 3) Weathered Cobble - 8" (face) x 12" D x 6" H (397 mm x 295 mm x 92mm)
- 4) Rectangular Cap - 15⁵/₈" (face) x 11⁵/₈" D x 3⁵/₈" H (397 mm x 295 mm x 92mm)

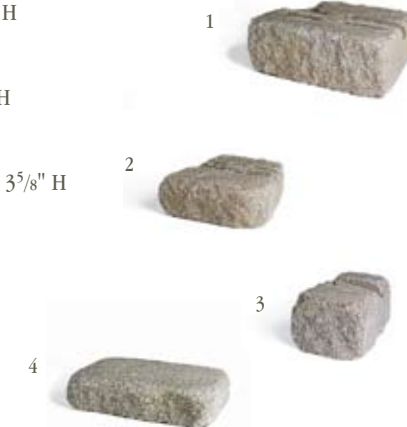

Stocked Weathered Versa-Lok® Colors:



Custom colors available upon request.
Due to variations in printing, all color selections should always be chosen from actual product samples.

Sculpted Landscapes

OMEGA retaining wall system



Value your time and money with the Omega Wall System. Using gravel-filled cores, these 7" units save you both material and labor costs by installing quickly and efficiently. Omega Walls can accommodate walls well over 4 feet designed when properly engineered with reinforcement.

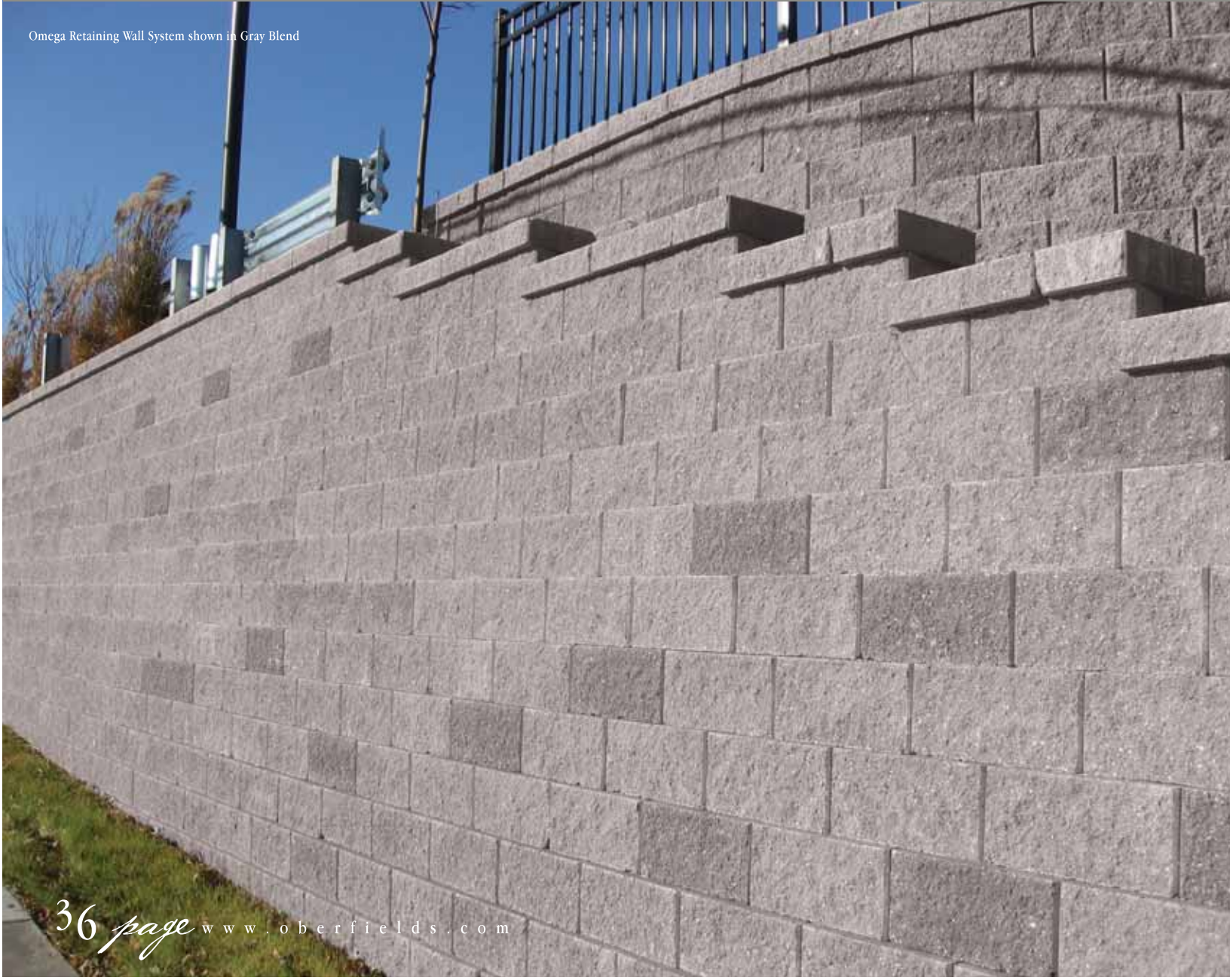

1) Omega Retaining Wall Straight Face Unit
Dimensions: 8" H x 18" W x 12" D
Face Area: 1.0 ft²
Weight: 78 lbs

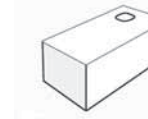

2) Retaining Wall Corner Unit
Dimensions: 8" H x 18" W x 9" D
Face Area: 1.0 ft² / 0.5 ft²
Weight: 75 lbs

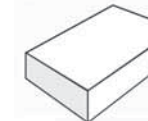

3) Retaining Wall Cap Unit
Dimensions: 3⁵/₈" H x 15⁵/₈" W x 11⁵/₈" D
Weight: 51 lbs

Installation:

Place first unit at the lowest level of elevation. Each unit must be leveled from side to side as well as front to back. Blocks must be installed with the tabs facing up. To aid in keeping the wall straight, place string line along the back side. Backfill each course and fill block voids with clean crushed stone. Sweep tops of units before installing next course.

Add additional rows of Omega Block by placing the center of the units over the intersection of two units from the previous row, making sure to pull the block forward so that the back of the block stops against the tabs of the two units below. This will create the system's native 1" setback. Fill block voids and backfill a minimum of 12" behind wall with clean crushed stone to allow proper drainage flow, preventing any

possible structural or drainage problems. Once all courses of Omega block are installed to your satisfaction, complete the installation by placing Retaining Wall Caps over the top course of Omega block. When placing caps, knock tabs off of top Omega course and secure caps with a suitable concrete or retaining wall adhesive. Caps may be installed flush to block, with an overhang, or set back to match the set back of the Omega block.

The Retaining Wall Corner can be used to create both right and left hand corners for the Omega Retaining Wall System by simply flipping it in the appropriate direction. The corner block may be tailored to many different applications by splitting it at any of the designated points.

Cross Section:

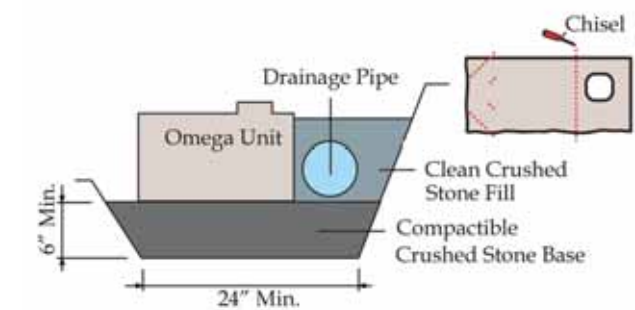
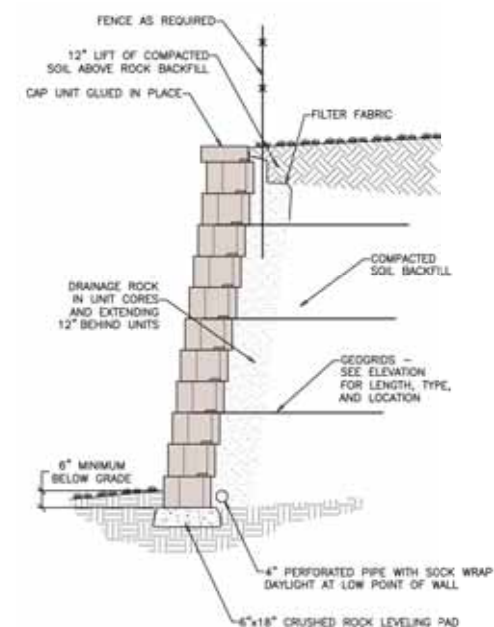

3 way split not available

Natures Beauty

EDINGTON™ WALL STONE

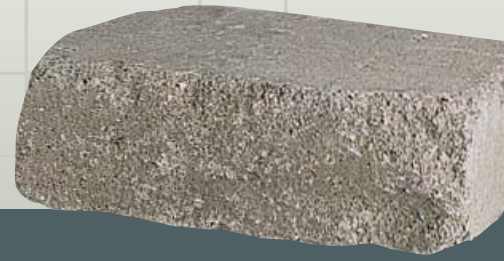

Perfect for the homeowner doing a small decorative wall, or a party-friendly seat wall, our Edington™ Wall Stone is an attractive and practical improvement upon nature's finest. It's the look of natural stone with the resilience and durability of our concrete manufacturing process. Edington™ Wall Stone requires no mortar and can be used in curved or straight walls, planters, columns and steps. Crafted in soft hues, Edington™ Wall Stone subtly blends in to complement any setting in an ageless fashion.

Edington™ Installation Configurations:

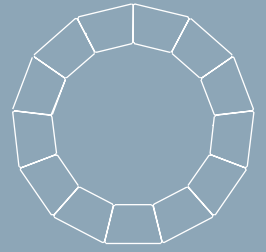
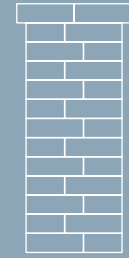
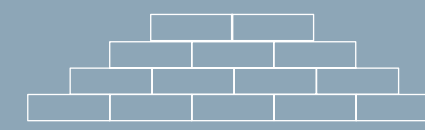
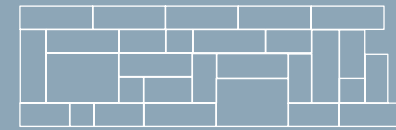

Edington™ Wall Stone shown in Flagstone Blend, Washington Circle pavers shown in Flagstone Blend with Charcoal Border

Edington™ Wall Stone shown in Earth Blend

Edington™ Wedge shown in Fieldstone



Edington™ Wall Stone shown in Earth Blend

- 1) Edington™ Wall Stone – 12" x 8" x 4"
(300mm x 200mm x 100mm)



- 2) Edington™ Wedge – 12" x 8" x 4"
(300mm x 200mm x 100mm)



- 3) Vintage Richfield® Large Rectangle – 11" x 8 1/4"
(280 mm x 210 mm) (Optional Cap)



Edington™ Wall Stone Stocked Colors:



Canyon Creek Blend



Earthstone Blend



Fieldstone



Flagstone Blend



Quarrystone



Sierrastone Blend

Custom colors available upon request.

Due to variations in printing, all color selections should always be chosen from actual product samples.

Natural Charm

ROSETTA® BELVEDERE COLLECTION retaining wall system



Enhance your landscape with the look of natural stone without the waste or expense. Belvedere incorporates the classic look of stone with a natural texture on both its front and back, making it a perfect choice for freestanding walls, columns or steps. Belvedere is a dimensional system that mimics the Rosetta Wall Stone Collection but scaled proportionately for a residential application.

Sample Wall Installation Configurations:

12" Wall Pattern



24" Wall Pattern

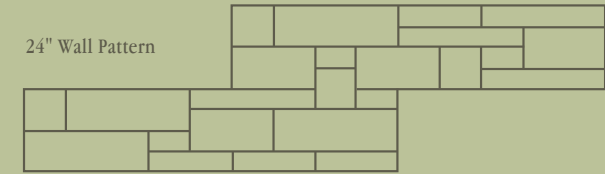

Rosetta® Belvedere Photo supplied by Rosetta®



Rosetta® Belvedere Wall Stone shown in Cuyahoga



Belvedere shown in Cuyahoga



Rosetta® Belvedere Wall Stone in Cuyahoga

- 1) Rosetta® Belvedere Wall Stone
 - Natural stone texture on both front and back
 - Attractive freestanding and retaining walls possible
 - Dimensional = fast installation and no waste
 - Natural color blends available
 - Walls, columns, steps and more = creative possibilities



Rosetta® Belvedere Colors:



Cuyahoga

Due to variations in printing, all color selections should always be chosen from actual product samples.

RETAINING WALL

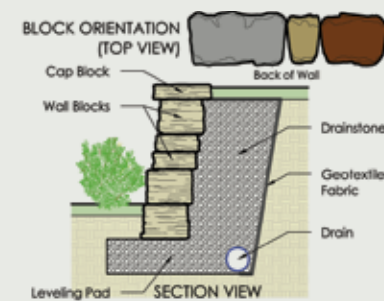

FREESTANDING WALL

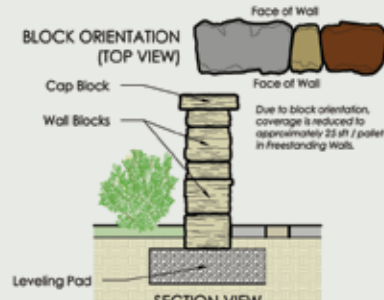

(See Technical Guide for Wall Design and Construction Details)



Rosetta® Belvedere Wall Stone in Cuyahoga



Rosetta® Belvedere Photo supplied by Rosetta®

Nature Defined

ROSETTA® OUTCROPPING COLLECTION retaining wall system



Unlock the beauty and nuance of nature itself in your outdoor setting with The Rosetta Outcropping Wall Collection. Incorporate the classic look of weather-hewn stone and steps in a variety of natural sculpted faces, ranging from 2' to 6' wide and 6" to 24" tall in 6" increments. Each piece is made of architectural-grade, precast concrete of the finest quality, the integrity of which will not be compromised by weather's unpredictable elements.

Sample Wall Installation Configurations:

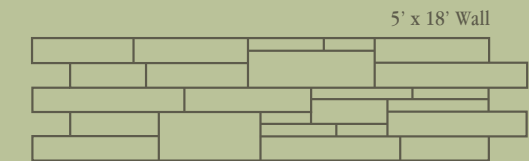
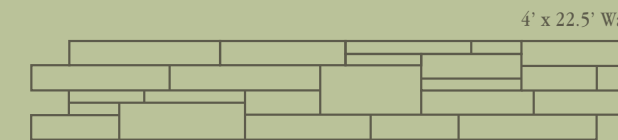

Rosetta® Outcropping Wall Stone and Steps shown in Cuyahoga



Rosetta® Outcropping Wall Stone and Steps shown in Cuyahoga



Rosetta® Dimensional Steps shown in Scioto

- 1) Rosetta® Outcropping Wall Stone – 12" H x 54" L – 1012 lbs. (unit shown is one of a 12 piece modular system)
- 2) Rosetta® Outcropping Wall Stone – 12" H x 42" L – 600 lbs. (unit shown is one of a 12 piece modular system)



Rosetta® Pond Kits available.
12 different sizes and shapes are available.

Rosetta® Wall Stone Colors:



Cuyahoga

Due to variations in printing, all color selections should always be chosen from actual product samples.

ROSETTA® STEPS

The classic look of weather-hewn steps lives on in the Rosetta Irregular Step Collection, available in 7" rises. The Quarry-chiseled look of the Rosetta Dimensional Steps comes in 36"x18", 48"x18", or "72"x30" sizes. Either style of Rosetta Steps builds a secure stairway like no other concrete product. All Rosetta steps have a uniform rise, require no shimming, and are very easy to install. All steps are available in our two color blends.



Rosetta® Dimensional Steps shown in Scioto®

Efficient Enhancements

HANDY WALL® & HANDY STONE II® retaining wall systems

Handy-Wall® and Handy-Stone II® units provide the easiest and most economical way to improve the look of any landscape. Perfect for small retaining walls, terraces, tree rings and planters, you will be pleased with the positive improvements even a small wall can make in your landscape design.

1) Rosetta® Irregular Steps

- All irregular steps have 7" rise
- a) 54" L x 22" D x 7" H (458 lbs.)
 - b) 60" L x 24" D x 7" H (600 lbs.)
 - c) 42" L x 17" D x 7" H (349 lbs.)
 - d) 48" L x 28" D x 7" H (567 lbs.)
 - e) 42" L x 26" D x 7" H (476 lbs.)
 - f) 48" L x 24" D x 7" H (512 lbs.)

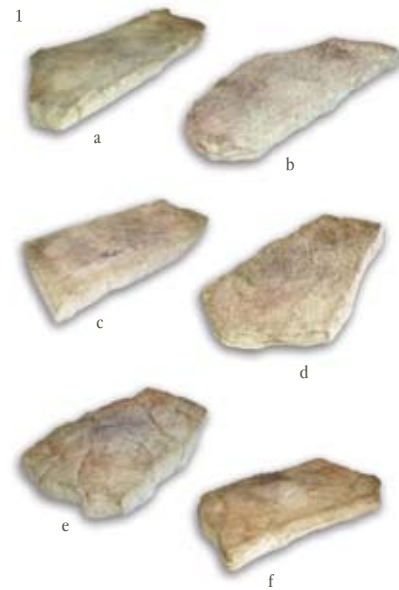

2) Rosetta® Dimensional Steps

- All dimensional steps have 7" rise
- a) 36" L x 18" D x 7" H (375 lbs.)
 - b) 48" L x 18" D x 7" H (455 lbs.)
 - c) 72" L x 30" D x 7" H (1320 lbs.)

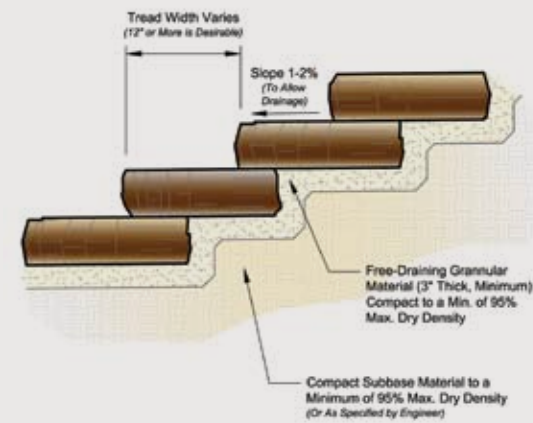
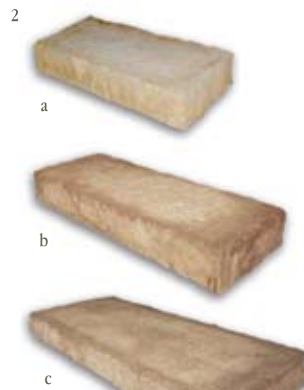

Handy Stone II® shown in Antique Blend



Handy Wall® shown in Buff (non-stock)
Vintage Washington Pavers shown in Flagstone Blend



Rosetta® Dimensional Steps shown in Cuyahoga

Rosetta® Irregular Step Colors:



Cuyahoga



Scioto

Due to variations in printing, all color selections should always be chosen from actual product samples.

- 1) Handy Stone II® - 8¹/₂"(face) x 6³/₄"(rear) x 6"D x 4"H (216mm x 171mm x 150mm x 100mm)

- 2) Handy-Wall® - 12"(face) x 9"(rear) x 9"D x 4"H (305mm x 220mm x 220mm x 100mm)



Handy-Wall® and Handy Stone II® have a rear lip for easy alignment and proper set back.

Stocked Handy Wall® & Handy Stone II® Colors:



Antique Blend



Earth Blend



Flagstone Blend

Custom colors available upon request.

Due to variations in printing, all color selections should always be chosen from actual product samples.

EDINGTON™ WALL STONE

INSTALLATION BASICS

- 20" maximum retaining wall or planter height.
- Piers and columns can be higher than 20".
- 3" minimum below-grade.
- 14" wide and 6" deep minimum base, well compacted.
- Base material: Crushed limestone, ranging from 3/4" in size to dust.
- Clean 3/4" gravel backfill.
- Use filter fabric to separate solid from gravel backfill.
- Offset vertical joints to maximize strength.
- Adhere units with concrete adhesive.

FREESTANDING OR SEATWALL APPLICATION

- 36" maximum wall height, minimum of one course below grade.
- 14" wide and 6" deep minimum base, well compacted.
- Offset joints to maximize strength.
- Adhere each course of wall with concrete adhesive.

COLUMN APPLICATION

- 48" maximum column height, minimum of one course below grade.
- 20" x 20" column width.
- 24" wide and 6" deep minimum base, well compacted.
- Adhere each course of wall with concrete adhesive.

NON-WEATHERED & WEATHERED VERSA-LOK® RETAINING WALL SYSTEM

BASE PREPARATION

- Set wall on leveling pad of well-compacted crushed stone or gravel approximately 6" thick and 24" wide.
- Excavate to lines and grades you've established for your wall, allowing for the leveling pad and unit embedment.
- Add thin layer of sand, if necessary, to create level pad.
- Embed first course of units below grade and approximately 1/10 of the exposed wall height.
- Place base units on prepared leveling pad. Carefully level each unit from front to back, side to side and with adjacent units.
- Align straight wall sections using a string line or by sighting down the slots in unit tops. If your wall has a corner begin there and work outward.
- Use native soil to backfill and compact behind and in front of the base course to a level even with the grade in front of the wall.
- Place and compact 12" of drainage aggregate behind units.

INSTALLING COURSES AND CAPS

- Stack units one course at a time.
- If installing with a 3/4" setback, insert two pins in front holes of units so they fall into the rear slots of the units beneath them.
- If installing with a near-vertical setback, pin through the rear holes in the upper units into the rear slots of the lower units.
- Tap pins with another pin and a mallet to ensure proper setting.
- Place and compact drainage aggregate behind each course as it is completed.
- After completing the top course, install caps, either with a light overhang, set back or flush with the wall face.
- Use concrete adhesive to secure cap units to wall.

HANDY-WALL® & HANDY-STONE II®

step 1 PREPARE BASE

Begin by excavating a trench approximately 12 inches wide by 4 inches deep. It is important to remove sod and other organic materials. It is also important to partially embed a portion of the bottom course to hold it firmly in place.

After excavating, make sure that the bottom of the trench is well compacted. Use a hand tamper to compact the soil if necessary. Spread a 1-inch layer of sand in the trench. The base is now ready for the course of Handy-Wall® or Handy-Stone II®.

step 2 POSITION BASE COURSE

Lay the base course units on your prepared base. You may remove a small amount of sand to make room for the alignment lips, or place base units upside down with alignment lips facing forward. Level each unit side to side, front to back, and with adjacent units. A rubber mallet will help to level units and a string line can be used to keep units straight.

step 3 LAY SUCCEEDING COURSE

Position the second course of Handy-Stone II units so that alignment lips overhang the back edge of the base course and edge joints are staggered with those of the lower units.

step 4 BACKFILL AS YOU PROCEED

Backfill behind each course as you proceed. Gravel backfill is recommended to help with drainage.

Continue laying additional courses and backfilling until desired height is achieved.

step 5 SECURE TOP COURSE (OPTIONAL)

Secure top units using a good concrete adhesive.

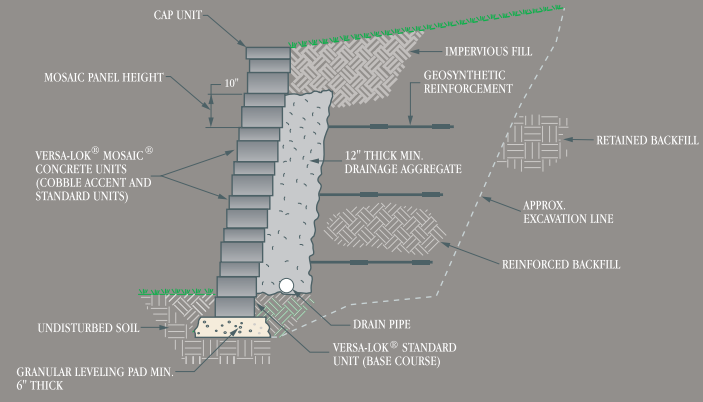

Impressive COMMERCIAL APPLICATIONS





WASHINGTON & WASHINGTON CIRCLE PAVERS

ADA PAVERS



Washington Circle Pavers shown in Albany Blend & Charcoal



Washington Pavers shown in Brown*



Washington Circle Pavers shown in Brown* w/ Flagstone Blend surround



ADA Pavers shown in Red
Monroe Pavers in Autumn Blend

1) ADA – 117/16" x 117/16" x 23/8"
(291mm x 291mm x 60mm)



ADA Paver Stocked Colors:

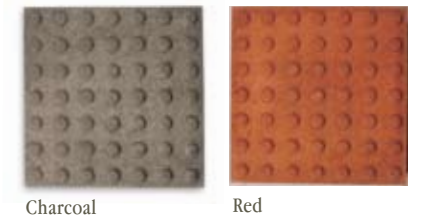

Charcoal

Red

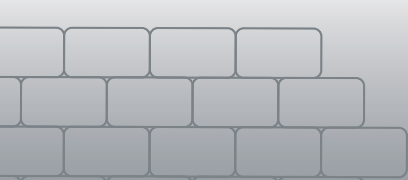

VINTAGE PAVERS



EDINGTON™ WALL STONE



Vintage Monroe Pavers shown in Charcoal®



Vintage Washington Pavers shown in Autumn Buff® & Granite Blend



Vintage Washington Pavers shown in Charcoal



Edington™ Wall Stone shown in Fieldstone & Quarrystone
Rockfaced Piercap in Gray

MONROE PAVERS

VERSA-LOK® SEGMENTAL RETAINING WALLS

Monroe Pavers shown in Albany Blend w/ Charcoal border & Brown & Buff star
Weathered Versa-Lok® Mosaic® Wall in Chestnut Blend
Vintage Washington Pavers in Flagstone Blend w/ Granite Blend border



Non-Weathered Versa-Lok® shown in Gray



Non-Weathered Versa-Lok® shown in Buff

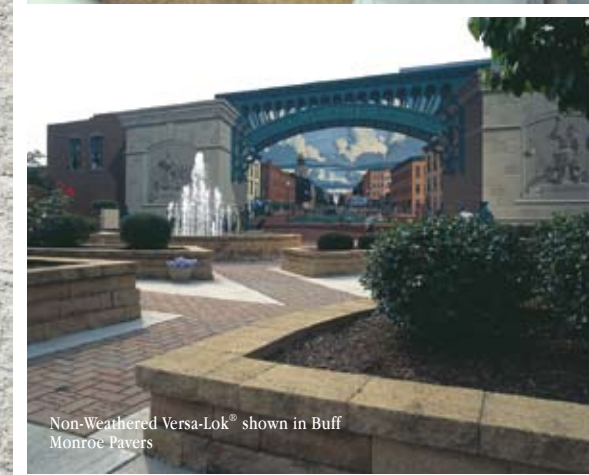

Non-Weathered Versa-Lok® shown in Buff
Monroe Pavers

WEATHERED VERSA-LOK® MOSAIC® RETAINING WALLS

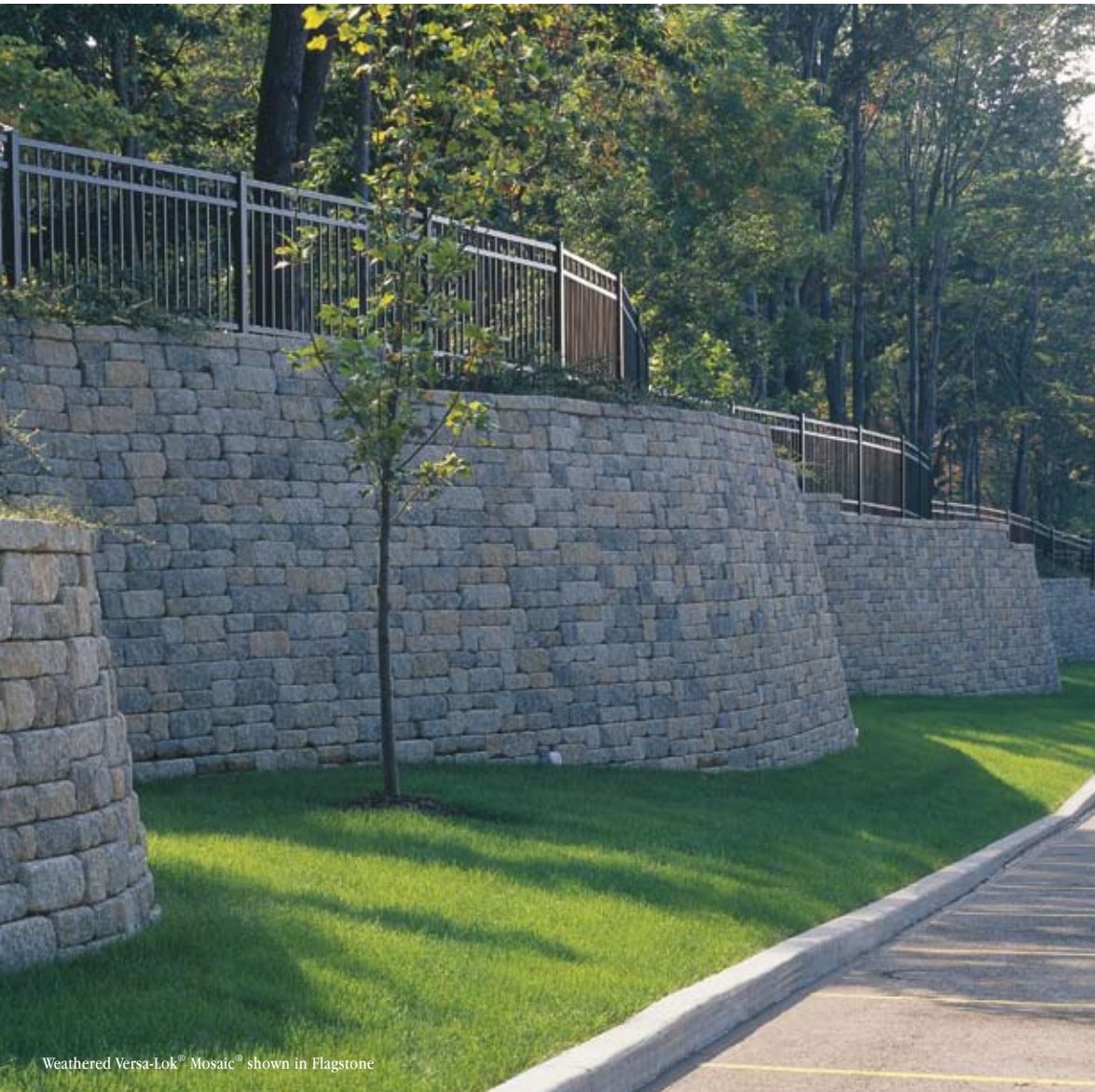

Weathered Versa-Lok® Mosaic® shown in Flagstone

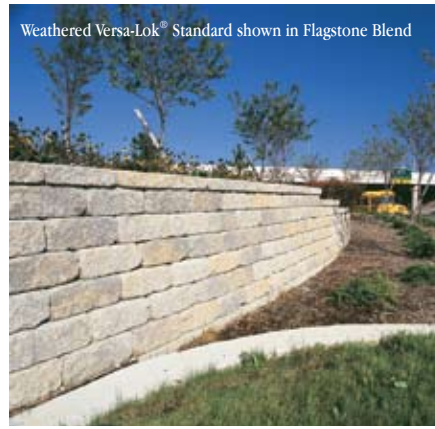

Weathered Versa-Lok® Standard shown in Flagstone Blend



Weathered Versa-Lok® Mosaic® shown in Flagstone Blend



Weathered Versa-Lok® Mosaic® shown in Chestnut Blend

QUICK INSTALLATION

- 

1 Set base plate on non-combustible foundation.
- 

2 Place centerbacks along rear of base plate and build smoke chamber.
- 

3 Install firebrick and fireplace is complete.

EMBERLOK MASONRY FIREPLACE SYSTEMS

Emberlok is a simple way to build a high-end, all masonry outdoor fireplace and chimney. This smartly designed system installs in a matter of hours for less than half the cost of a traditional brick and mortar fireplace. And it enhances the value of any outdoor living space.



Emberlok Fireplace with Stack Stone (Stack Stone sold separately)



Model		Overall Height	Overall Depth	Overall Width	Overall Diameter	Firebox Opening Height	Smoke Chamber Height	Weight in Pounds
30"	Outdoor Fireplace	76.63"	28.5"	38"	n/a	29.38"	23"	1900
36"	Outdoor Fireplace	84.75"	28.5"	44"	n/a	38"	23"	2100
42"	Outdoor Fireplace	106.13"	28.5"	50"	n/a	38"	32.5"	2600
36"	Arched Front Outdoor Fireplace	84.75"	28.5"	44"	n/a	34"*	23"	2160
42"	Arched Front Outdoor Fireplace	106.13"	28.5"	50"	n/a	34"*	32.5"	2670

Custom sized rectangular EmberPits available; call your Emberlok distributor for pricing. *Measurement at top of arch. ** Height Extension Kit adds 6 inches to overall height. The kit also adds 320-1512 lbs depending on the width of the EmberPit.

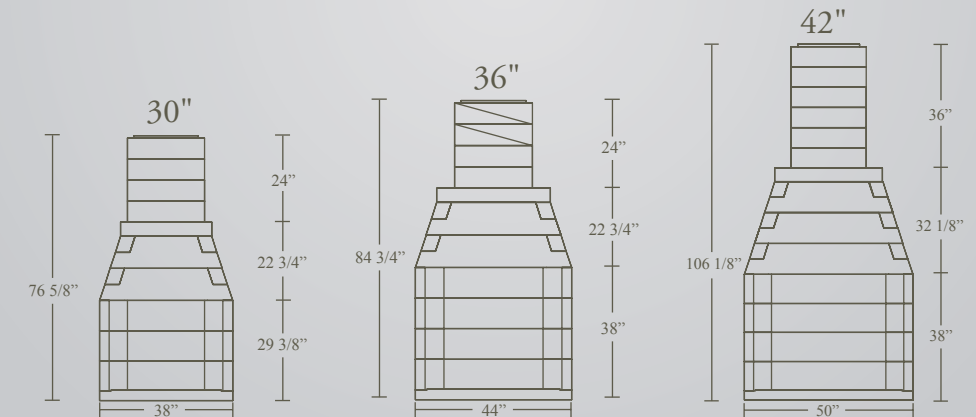



INSTALLATION RECOMMENDATIONS

PAVER INSTALLATION

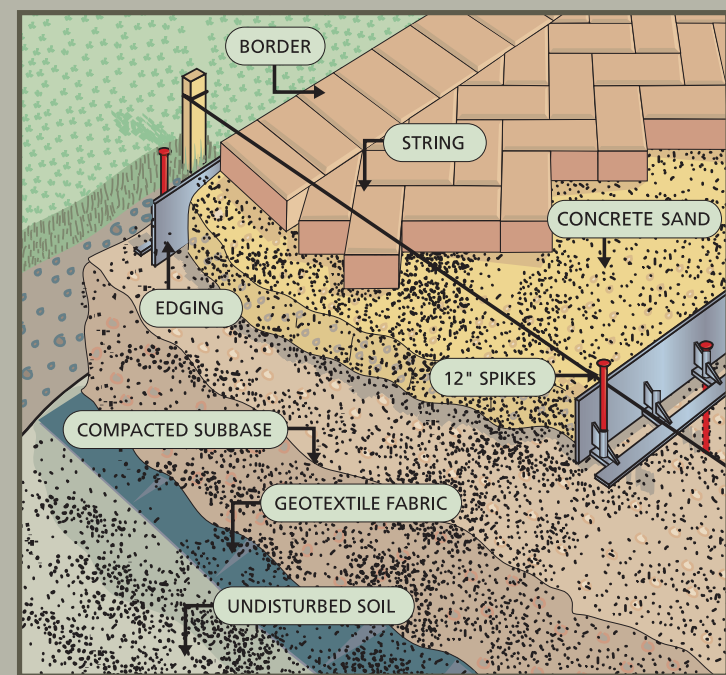

EDINGTON™ WEDGE WALL STONE FIREPIT

13 PIECES PER LAYER FOR 4' OUTSIDE TO OUTSIDE DIAMETER

GRATE SOLD SEPARATELY

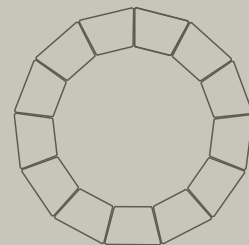

EDINGTON™ WALL STONE COLUMN DETAIL

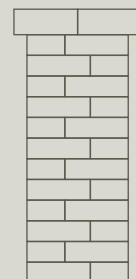

VERSA-LOK® STAIR INSTALLATION DETAIL

STAIR DETAIL
BASE PEDESTAL METHOD
SCALE: 1/2" = 1'

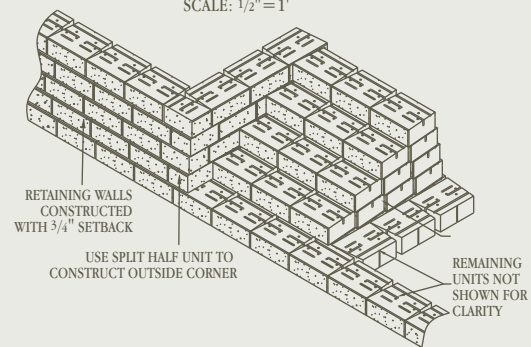

STAIR RISER DETAIL 1
BASE PEDESTAL METHOD (RECOMMENDED)
SCALE: 3/8" = 1'

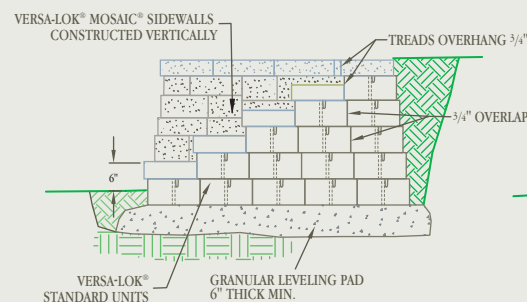

STAIR RISER DETAIL 2
"CUT IN" METHOD
SCALE: 3/8" = 1'

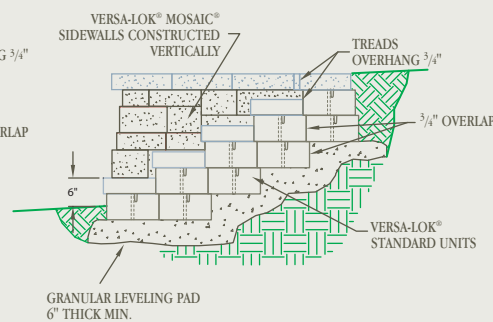

ESTIMATING GUIDES

ESTIMATING

MATERIALS ESTIMATION WORKSHEET

VERSA-LOK® Units

Area of Wall (SF) x 1.5 Units per SF = Number of Units

_____ SF x 1.5 = _____ Units Needed

VERSA-TUFF® Pins

Units x 2 Pins per Unit = Number of Pins

_____ Units x 2 = _____ Pins Needed

Caps

Lineal Feet of Wall (LF) x .75 = Number of Caps

_____ LF x .75 = _____ Caps Needed

Concrete Adhesive

11 oz. Tube: 12 LF per Tube

_____ LF ÷ 12 = _____ Tubes Needed

ESTIMATING—MOSAIC®

MATERIALS ESTIMATION WORKSHEET FOR MOSAIC®

VERSA-LOK® Standard Units

Area of Wall (SF) ÷ 1.66 = Number of Standard Units

_____ SF ÷ 1.66 = _____ Standard Units Needed

VERSA-LOK® Cobble Units

Area of Wall (SF) ÷ 1.66 = Number of Cobble Units

_____ SF ÷ 1.66 = _____ Cobble Units Needed

VERSA-LOK® Accent Units

Area of Wall (SF) ÷ 1.66 x 2 = Number of Accent Units

_____ SF ÷ 1.66 x 2 = _____ Accent Units Needed

VERSA-TUFF® Snap-off Pins

Area of Wall (SF) ÷ 1.66 x 8 = Number of Pins

_____ SF ÷ 1.66 x 8 = _____ Pins Needed

Caps

Lineal Feet of Wall (LF) x .75 = Number of Caps

_____ LF x .75 = _____ Caps Needed

Concrete Adhesive

11 oz. Tube: 12 LF per Tube

_____ LF ÷ 12 = _____ Tubes Needed

BASE COURSE

When using all VERSA-LOK® Standard units for the base course, estimate the base course separate from the exposed wall square footage.

Assuming only 1 course of embedment:

Lineal Feet of Wall (LF) x .75 = Number of Standard Units for Base Course

_____ LF x .75 = Standard Units Needed

Base course of VERSA-LOK® Standard units does not require pins.

PLANNING, ESTIMATING & FINAL DESIGNS Visit oberfields.com for estimating calculators and other helpful tools

MOSAIC® UNIT ESTIMATION CHART

Each Mosaic® panel is 1.66 square feet in wall-face area. For each panel, there is one Standard unit, two Accent units, and one Cobble unit. The following formulas and table may be used to estimate quantities of units required for a Mosaic® retaining wall project.

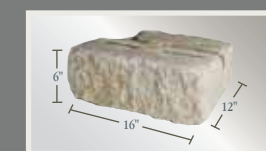

No. of STANDARD UNITS =
Wall Square Footage ÷ 1.66

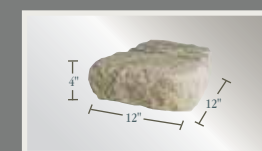

No. of ACCENT UNITS =
Wall Square Footage ÷ 1.66 x 2

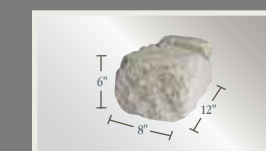

No. of COBBLE UNITS =
Wall Square Footage ÷ 1.66

VERSA-LOK® MOSAIC® UNIT QUANTITY ESTIMATION CHART*

each panel requires 8 pins

EXPOSED WALL Height	EXPOSED WALL Length	10 feet	12 feet	14 feet	16 feet	18 feet	20 feet	22 feet	24 feet	26 feet	28 feet	30 feet
10 inches	Standard	5	6	7	8	9	10	11	12	13	14	15
	Cobble	5	6	7	8	9	10	11	12	13	14	15
	Accent	10	12	14	16	18	20	22	24	26	28	30
20 inches	Standard	10	12	14	16	18	20	22	24	26	28	30
	Cobble	10	12	14	16	18	20	22	24	26	28	30
	Accent	20	24	28	32	36	40	44	48	52	56	60
30 inches	Standard	15	18	21	24	27	30	33	36	39	42	45
	Cobble	15	18	21	24	27	30	33	36	39	42	45
	Accent	30	36	42	48	54	60	66	72	78	84	90
40 inches	Standard	20	24	28	32	36	40	44	48	52	56	60
	Cobble	20	24	28	32	36	40	44	48	52	56	60
	Accent	40	48	56	64	72	80	88	96	104	112	120

*This chart does not include estimates for embedded (buried) units. The quantity of embedded units (generally all Standard units) should also be added to these quantities.

Maximum Impact

DESIGN ELEMENTS

When planning your patio, think about adding the little extras into your design that can really set your space apart from others. Make it a more usable space with the addition of landscape lighting, a fireplace that serves as the focal point, a calming water feature, an outdoor kitchen for entertaining that includes a concrete countertop. Add a sealer to your patio to enhance the richness of your pavers. With a little extra effort, your patio can become a real design element. Let Oberfields assist you with these extra design elements.

Landscape Lighting

Nothing showcases the textures and beauty of your hardscape more than landscape lighting. Uplight your plantings, add task lighting to stairs, add ambient lighting to walls or water features. Landscape lighting can transform your patio after dark to a dramatic outdoor living space.



Fireplaces

Whether it's a simple fire ring or an all-masonry outdoor fireplace and chimney, a fireplace element within your patio can enhance the value of any outdoor living space.



Washington Pavers in Flagstone Blend
Weathered Versa-Lok® Mosaic® in Flagstone Blend



Sealers

Add a little richness and warmth to your pavers by adding a sealer or enhancer. Available in several finishes, sealers and enhancers can protect the investment that you have made.



PACKAGING REFERENCE GUIDE

PAVER PRODUCTS	STOCKED	DIMENSIONS	NOMINAL DIMENSIONS	WEIGHT PER SQ. FT.	UNITS PER SQ. FT.	UNITS PER BAND	UNITS PER CUBE	WEIGHT PER CUBE	SQ. FT. PER UNIT	SQ. FT. PER BAND	SQ. FT. PER CUBE	COLORS STOCKED
Washington Circle	X	Circle Center, Small Circle Paver, Large Circle Paver	N/A	27.6	N/A	N/A	318	1380	Varies	N/A	50	Albany, Antique, Autumn, Canyon Creek, Charcoal, Earth, Flagstone, Granite
Washington 10	X	4 1/8" x 5 1/2" x 2 3/8"	105 mm x 140 mm x 60 mm	27.6	6.34	80	640	2788	0.16	12.61	101	Albany, Antique, Autumn, Canyon Creek, Charcoal, Earth, Flagstone, Granite
Washington 14	X	5 1/2" x 5 1/2" x 2 3/8" *	140 mm x 140 mm x 60 mm	27.6	4.76	60	480	2760	0.21	12.50	100	Albany, Antique, Autumn, Canyon Creek, Charcoal, Earth, Flagstone, Granite
Washington 21	X	5 1/2" x 8 1/4" x 2 3/8" *	140 mm x 210 mm x 60 mm	27.6	3.17	54	324	2815	0.32	17.00	102	Albany, Antique, Autumn, Canyon Creek, Charcoal, Earth, Flagstone, Granite
Monroe	X	4" x 8" x 2 3/8" *	100 mm x 200 mm x 60 mm	27.6	4.70	81	486	2843	0.21	17.17	103	Albany, Antique, Autumn, Charcoal, Earth, Flagstone, Granite
Monroe 4		4" x 8" x 2 3/8" *	100 mm x 200 mm x 60 mm	27.6	4.70	81	486	2843	0.21	17.17	103	N/A
Monroe 8		8" x 8" x 2 3/8"	200 mm x 200 mm x 60 mm	27.6	2.35	40	240	2815	0.43	17.00	102	N/A
Monroe 12	X	12" x 12" x 2 3/8"	300 mm x 300 mm x 60 mm	27.6	1.00	24	96	2650	1.00	24.00	96	Antique, Gray, Red
Lincoln Edge		4 5/16" x 8 5/8" x 2 3/8"	110 mm x 220 mm x 60 mm	27.6	4.80	50	500	2870	0.21	10.40	105	Special Order Only
Lincoln		6 1/8" x 8 5/8" x 2 3/8"	155 mm x 220 mm x 60 mm	27.6	3.80	80	400	2898	0.26	21.00	104	Special Order Only
Monoslab Grass Paver	X	15 5/8" x 23 1/2" x 4 1/2"	397 mm x 597 mm x 114 mm	27.6	0.37	N/A	42	3780	2.70	N/A	113	Gray
Turfstone Grass Paver	X	15 3/4" x 22 5/8" x 3 1/8"	400 mm x 600 mm x 80 mm	27.6	0.37	N/A	48	2784	2.70	N/A	128	Gray
Vintage Washington 10	X	4 1/8" x 5 1/2" x 2 3/8"	105 mm x 140 mm x 60 mm	27.6	6.34	80	640	2788	0.16	12.61	101	Autumn, Canyon Creek, Earth, Flagstone, Granite
Vintage Washington 14	X	5 1/2" x 5 1/2" x 2 3/8"	140 mm x 140 mm x 60 mm	27.6	4.76	60	480	2760	0.21	12.50	100	Autumn, Canyon Creek, Earth, Flagstone, Granite
Vintage Washington 21	X	5 1/2" x 8 1/4" x 2 3/8"	140 mm x 210 mm x 60 mm	27.6	3.17	54	324	2815	0.32	17.00	102	Autumn, Canyon Creek, Earth, Flagstone, Granite
Vintage Washington Circle	X	Circle Center, Small Circle Paver, Large Circle Paver	N/A	27.6	N/A	N/A	318	1380	Varies	N/A	50	Autumn, Canyon Creek, Earth, Flagstone, Granite
Vintage Belhaven® Small Rectangle	X	5 1/2" x 2 3/4" x 2 3/4"	140 mm x 70 mm x 70 mm	32.0	9.52	96	768	2592	0.11	10.56	81	Bluestone, Canyon Creek, Earth, Flagstone
Vintage Belhaven® Small Square	X	5 1/2" x 5 1/2" x 2 3/4"	140 mm x 140 mm x 70 mm	32.0	4.76	48	384	2592	0.21	10.08	81	Bluestone, Canyon Creek, Earth, Flagstone
Vintage Belhaven® Standard Rectangle	X	8 1/4" x 5 1/2" x 2 3/4"	210 mm x 140 mm x 70 mm	32.0	3.17	48	288	2912	0.32	15.36	91	Bluestone, Canyon Creek, Earth, Flagstone
Vintage Belhaven® Large Rectangle	X	11" x 8 1/4" x 2 3/4"	280 mm x 210 mm x 70 mm	32.0	1.58	32	128	2592	0.63	20.16	81	Canyon Creek, Earth, Flagstone
Vintage Belhaven® Large Square	X	11" x 11" x 2 3/4"	280 mm x 280 mm x 70 mm	32.0	1.19	24	96	2592	0.84	20.16	81	Canyon Creek, Earth, Flagstone
Vintage Belhaven® Jumbo Rectangle	X	16 1/2" x 11" x 2 3/4"	420 mm x 280 mm x 70 mm	32.0	0.79	16	64	2592	1.27	20.32	81	Canyon Creek, Earth, Flagstone
Vintage Belhaven® Circle	X	Circle Center, Small Circle Paver, Large Circle Paver & Rectangle Circle Paver	N/A	32.0	N/A	N/A	704	3520	Varies	N/A	110	Canyon Creek, Earth, Flagstone
Vintage Richfield® Small Square	X	5 1/2" x 5 1/2" x 2 3/4"	140 mm x 140 mm x 70 mm	32.0	4.76	48	384	2592	0.21	10.08	81	Earth, Flagstone
Vintage Richfield® Standard Rectangle	X	8 1/4" x 5 1/2" x 2 3/4"	210 mm x 140 mm x 70 mm	32.0	3.17	48	288	2912	0.32	15.36	91	Earth, Flagstone
Vintage Richfield® Large Rectangle	X	11" x 8 1/4" x 2 3/4"	280 mm x 210 mm x 70 mm	32.0	1.58	32	128	2592	0.63	20.16	81	Earth, Flagstone
Rosetta® Grand Flagstone	X	15 unique shapes at 1 3/4" thickness	291 mm x 291 mm x 60 mm	N/A	1.10	N/A	64	1664	0.91	N/A	58	Cuyahoga Blend
ADA Paver	X	11 7/16" x 11 7/16" x 2 3/8"	140 mm x 210 mm	36.4	3.17	N/A	154	1929	0.32	N/A	53	Charcoal, Red
Washington 21 Full Permeable Paver (vintage available)		5 1/2" x 8 1/4"	140 mm x 105 mm	36.4	6.34	N/A	28	1929	0.16	N/A	53	Special Order Only
Washington 21 Half Permeable Paver (vintage available)		5 1/2" x 4 1/8"										Special Order Only
StoneTile Abruzzo & StoneTile Tuscanni	X	15 3/4" x 15 3/4" x 1 9/16"	400 mm x 400 mm x 40 mm	18.5	.58	N/A	56	1791	1.72	N/A	96	Caramel Ferrous
StoneTile Abruzzo & StoneTile Tuscanni	X	15 3/4" x 23 5/8" x 1 9/16"	400 mm x 600 mm x 40 mm	18.5	.39	N/A	56	2706	2.58	N/A	144	Cappuccino, Roccia Blu

RETAINING WALL PRODUCTS	STOCKED	DIMENSIONS	NOMINAL DIMENSIONS	WEIGHT PER UNIT	UNITS PER SQ. FT.	UNITS PER BAND	UNITS PER CUBE	WEIGHT PER CUBE	SQ. FT. PER UNIT	SQ. FT. PER BAND	SQ. FT. PER CUBE	COLORS STOCKED
Non-Weathered Versa-Lok® Standard	X	16" front x 12" depth x 6" height	406 mm x 305 mm x 152 mm	82	1.50	N/A	36	2952	0.667	N/A	~24.00	Antique, Buff, Charcoal, Chestnut, Earth, Flagstone, Granite, Gray
Non-Weathered Versa-Lok® Accent	X	12" front x 12" depth x 4" height	305 mm x 305 mm x 102 mm	40	3.00	N/A	64	2880	0.333	N/A	~24.00	Chestnut, Earth, Flagstone, Granite
Non-Weathered Versa-Lok® Cobble	X	8" front x 12" depth x 6" height	203 mm x 305 mm x 152 mm	40	3.00	N/A	72	2880	0.333	N/A	~24.00	Chestnut, Earth, Flagstone, Granite
Non-Weathered Rectangular Retaining Wall Cap	X	15 5/8" front x 11 5/8" depth x 3 5/8" height	397 mm x 295 mm x 92 mm	51	N/A	N/A	60	2700	N/A	N/A	N/A	Antique, Buff, Charcoal, Chestnut, Earth, Flagstone, Granite, Gray
Handy-Wall®	X	12" front x 9" depth x 4" height	305 mm x 220 mm x 100 mm	30	3.00	N/A	96	2880	0.330	N/A	~32.00	Antique, Earth, Flagstone
Handy-Stone II®	X	8 1/2" front x 6" depth x 4" height	216 mm x 150 mm x 100 mm	13	4.17	N/A	192	2496	0.240	N/A	~45.00	Antique, Earth, Flagstone
Weathered Versa-Lok® Standard	X	16" front x 12" depth x 6" height	406 mm x 305 mm x 152 mm	82	1.50	N/A	36	2952	0.667	N/A	~24.00	Chestnut, Earth, Flagstone, Granite
Weathered Versa-Lok® Accent	X	12" front x 12" depth x 4" height	305 mm x 305 mm x 102 mm	40	3.00	N/A	64	2880	0.333	N/A	~21.00	Chestnut, Earth, Flagstone, Granite
Weathered Versa-Lok® Cobble	X	8" front x 12" depth x 6" height	203 mm x 305 mm x 152 mm	40	3.00	N/A	72	2880	0.333	N/A	~24.00	Chestnut, Earth, Flagstone, Granite
Weathered Rectangular Retaining Wall Cap	X	15 5/8" front x 11 5/8" depth x 3 5/8" height	397 mm x 295 mm x 92 mm	51	N/A	N/A	60	3060	N/A	N/A	N/A	Chestnut, Earth, Flagstone, Granite
Omega Wall Retaining Wall System (Straight face)	X	18" front x 12" depth x 8" height	457 mm x 305 mm x 203 mm	78	1.00	N/A	36	2808	1.0	N/A	36.00	Special Order Only
Edington™ Wall Stone	X	12" front x 8" depth x 4" high	300 mm x 200 mm x 100 mm	30	3.00	N/A		N/A	0.666	N/A	40.00	Autumnstone, Earthstone, Fieldstone, Flagstone, Quarrystone, Sierrastone
Edington™ Wedge*	X	12" front x 8" depth x 4" high	300 mm x 200 mm x 100 mm	25	N/A		96		N/A	N/A	N/A	Autumnstone, Earthstone, Fieldstone, Flagstone, Quarrystone, Sierrastone
Rosetta® Belvedere Collection	X	Wall, Coping, and Corner Pallets available										Cuyahoga

SPECIAL NOTES

* Asterick denotes non-stocked color

All Circle Cubes are sold as a full cubes only.

Larger circles can be obtained by adding additional Washington 10's or Belhaven® Small Rectangle & Small Square.

Due to the complex size of the pieces in a circle, there will be some extra pieces.

Weight per Cube does not include pallet weight.

*Washington 14 & 21 & Vintage Washington 14 & 21 shapes are also available in 80 mm series.

*Monroe and Monroe 4 and Vintage Monroe and Monroe 4 shapes are also available in 80 mm series.

To figure Lincoln Edges: Lineal Footage x .28 = Square Feet. Square Feet x 4.8 = Number of Pieces.

Special Order Non-Stock Paver and Retaining Wall Set-Up Charges:

less than 1,000 square feet = \$750 per shape/color/size;

1,000-2,999 square feet = \$500 per shape/color/size;

3,000 square feet and over = no set up charge

Paver Color Blends: Albany = red, brown, terra cotta; Antique = charcoal, red; Autumn = buff, charcoal, red; Canyon Creek = buff, charcoal, red; Earth = brown, buff, charcoal; Flagstone = buff, charcoal, gray; Granite = charcoal, gray

Due to color variations of pavers, it is advisable to remove them from the top to the bottom of the cube, versus removing by layers. When possible, install from 3 cubes at a time.

Retaining Wall Color Blends: Antique = charcoal, red; Chestnut = brown, buff; Earth Blend = brown, buff, charcoal; Flagstone = buff, charcoal, gray; Granite = charcoal, gray

Sq. Ft. = Square Foot